

SPECTRACOOL NARROW WITH ADVANCED CORROSION PROTECTION OVERVIEW

SPECTRACOOL Corrosion Protection Solutions provide the industry leading corrosion protection to components critical to the performance of the air conditioner. For applications where air conditioners are exposed to harsh, corrosive, chemical elements. Hoffman utilizes advanced coatings to protect the critical components, extending their life and optimizing the extended performance level of the product.

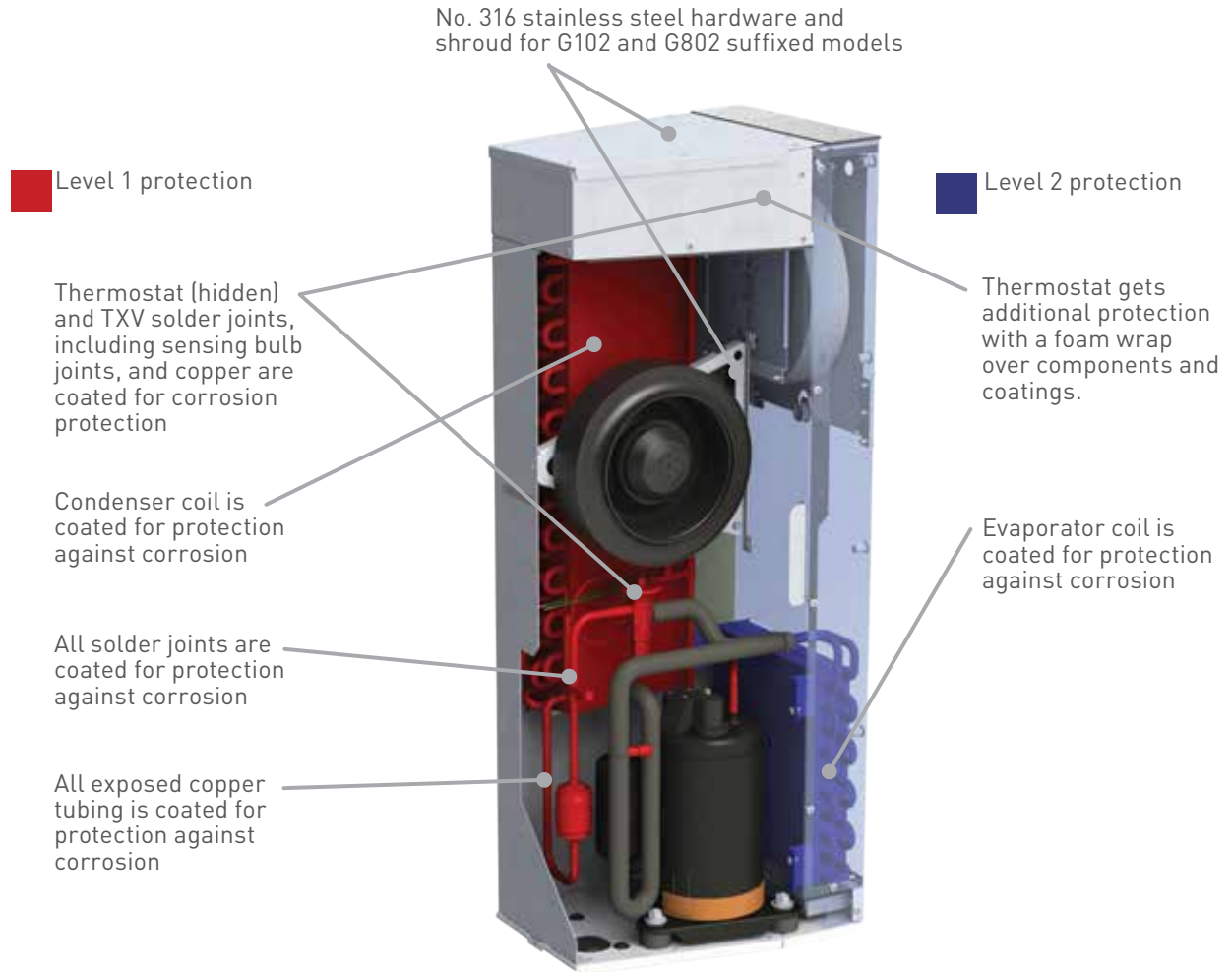

SPECTRACOOL NARROW WITH ADVANCED CORROSION PROTECTION COMPACT



N16 115/230 Volt
800 BTU/Hr.
234 Watt

N21 115/230 Volt
2000 BTU/Hr.
586 Watt

INDUSTRY STANDARDS

UL/cUL Listed; Type 12, 3R, 4, 4X optional; File No. SA6453
UR/cUR Recognized on select models for N16 and N21

CE
IP 56 Internal Loop
IP 34 External Loop
EAC
Telcordia GR-487 capable (Outdoor)
Reference performance data tables for agency approvals applied to each model.

APPLICATION

- Oil and gas
- Water treatment facilities
- Chemical manufacturing
- Industrial automation
- Package handling equipment
- Security and defense systems

FEATURES

- Two levels of corrosion protection:
 - Level 1 - Protective coatings on all exposed copper tubing and solder joints, condenser coil and thermostat.
 - Level 2 - All protective coatings in Level 1 plus a coated evaporator coil. Foam wrap added over protective coatings on thermostat.
- Narrow design accommodates 12-in. deep cabinets
- R134a earth-friendly refrigerants
- Models for 115, 230 and 400/460 VAC power input
- UL Listed to save customers time and money with agency approvals
- Attractive industrial design with minimal use of visible fasteners
- Reliable mechanical thermostat is located behind the cover of the unit; Air Conditioner models include digital display on ambient side
- Galvanized sheet-metal cover for rugged factory and outdoor environments
- Easy-mount flanges for simple installation
- Cutout adapter options for enclosures with GENESIS air conditioners enable users to easily transition to the new unit
- Dust-resistant condenser coil allows the unit to be run filterless in most applications
- Cleanable, reusable aluminum mesh filter protects coils for maximum cooling performance
- Mounting hardware, gaskets and user manual furnished with the unit
- Every unit functionally tested before shipping
- Standard models include:
 - Active condensate management
 - Power-off relay for door switch and other system requirements
 - Malfunction switch

SPECIFICATIONS

- Nominal cooling capacity:
 - N16 800 BTU/Hr. (234 W)
 - N21 2000 BTU/Hr. (586 W)
- Operating temperature range from 50 F/10 C to 125 F/52 C

FINISH

- RAL 7035 light-gray, semi-textured powder-coat paint
- No. 4 brushed 316 stainless steel
- Other colors and textures available

NOTES

Visit <http://hoffman.nvent.com/en/hoffman/SPECTRACOOL-Remote-Access-Control-472042> for more information regarding SPECTRACOOL Remote Access Control (RAC).

Visit <https://hoffman.nvent.com/en/hoffman/thermal-management> to download 2D and 3D CAD drawings into the overall design of your electrical system.

Performance Data N16 800 BTU/Hr. (234 Watt) Models

CATALOG NUMBER		
Level 1 Painted Galvanized - G700	N160116G700	N160126G700
Level 1 Stainless Steel 316 - G102	N160116G102	N160126G102
Level 2 Painted Galvanized - G800	N160116G800	N160126G800
Level 2 Painted with Remote Access Control - G360*	N160116G360	N160126G360
Level 2 Stainless Steel 316 - G802	N160116G802	N160126G802
COOLING PERFORMANCE		
Nominal:**		
BTU/Hr.	800	800
Watts	234	234
At Maximum Operating Temperatures:		
BTU/Hr. (50/60 Hz)	NA/819	920/960
W (50/60 Hz)	NA/240	270/281
At 95 F/95 F (35 C/35 C):		
BTU/Hr. (50 /60 Hz)	770/948	810/955
W (50/60 Hz)	226/278	237/280
Refrigerant	R134A	R134A
Refrigerant Charge (ounces/grams)	4/113	3.8/107
Operating Temperature Range:		
Maximum (°F/°C)	125/131/52/55	125/131/52/55
Minimum (°F/°C)	-40/-40	-40/-40
Airflow at 0 Static Pressure:		
Internal loop 50 Hz (CFM / m ³ /hr.)	25/42	25/42
External loop 50 Hz (CFM / m ³ /hr.)	48/82	48/82
Internal loop 60 Hz (CFM / m ³ /hr.)	30/51	30/51
External loop 60 Hz (CFM / m ³ /hr.)	53/90	53/90
ELECTRICAL DATA		
Rated Voltage	100/115	220/230
Frequency (Hz)	50/60	50/60
Operating Range	+/- 10%	+/- 10%
Max. Power Consumption (W at 50/60 Hz)	360/403	330/345
Max. Nominal Current (A at 50/60 Hz)	3.8/3.7	1.6/1.6
Starting Current (A)	8.0/9.2	3.3/3.1
Agency Approvals	cUL Listed CE EAC Others available upon request	
Power Input Description	Terminal Block	Terminal Block
ENCLOSURE PROTECTION		
UL Type	Type 12, 3R, 4 standard Type 4X Stainless steel optional	
CONTROLLER		
Description	Basic mechanical thermostat	
Thermostat Location	Enclosure behind front panel	
Factory Thermostat Setting (°F/°C)	80/27	
SOUND LEVEL		
At 1.5 Meters	63 dB(A)	
UNIT DIMENSIONS		
Height (in./mm)	16.51/419	
Width (in./mm)	7.52/191	
Depth (in./mm)	6.30/160	
Weight (lb./kg)	27/12	

*Units with Remote Access Control utilize a digital controller and communicate via EtherNet/IP, Profinet, Modbus TCP/IP and SNMP over ethernet or modbus RTU over USB.

**Performance values are nominal. For actual values, see performance curves.

Performance Curves for N16 Models 800 BTU/Hr. (234 Watt)

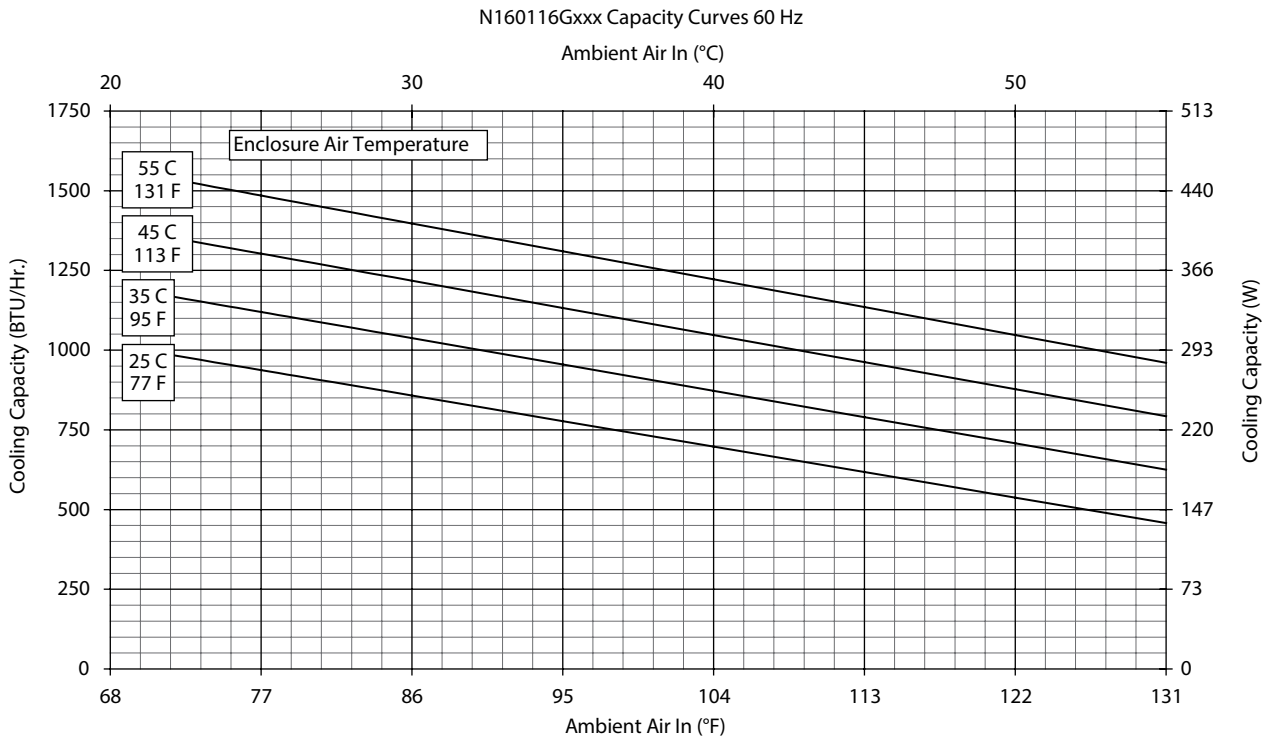
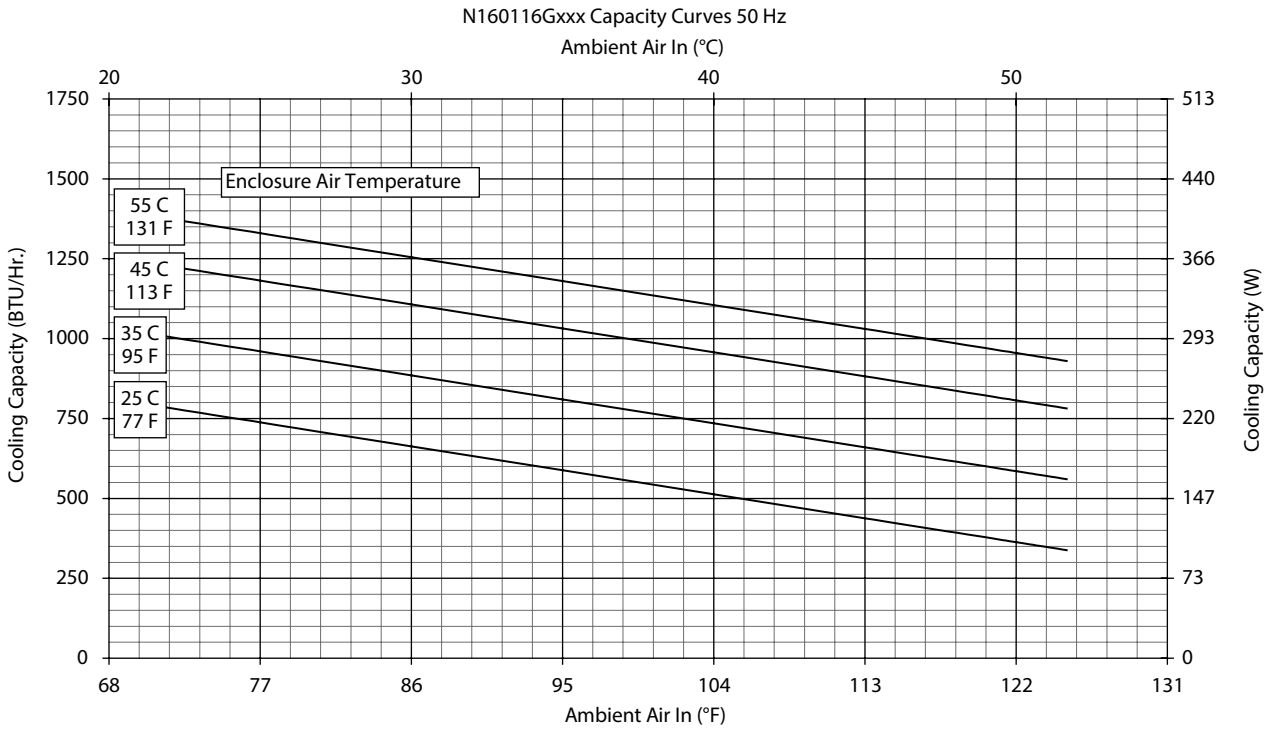

Performance Curves for N16 Models 800 BTU/Hr. (234 Watt)

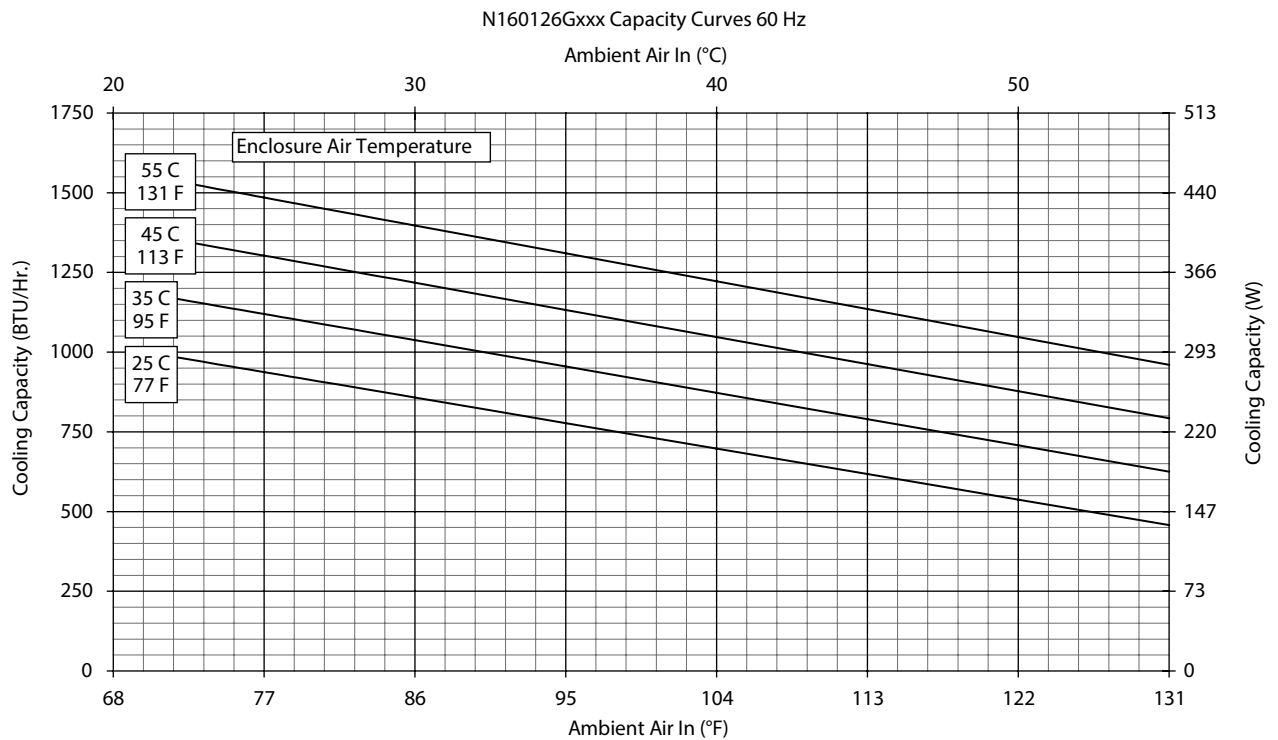
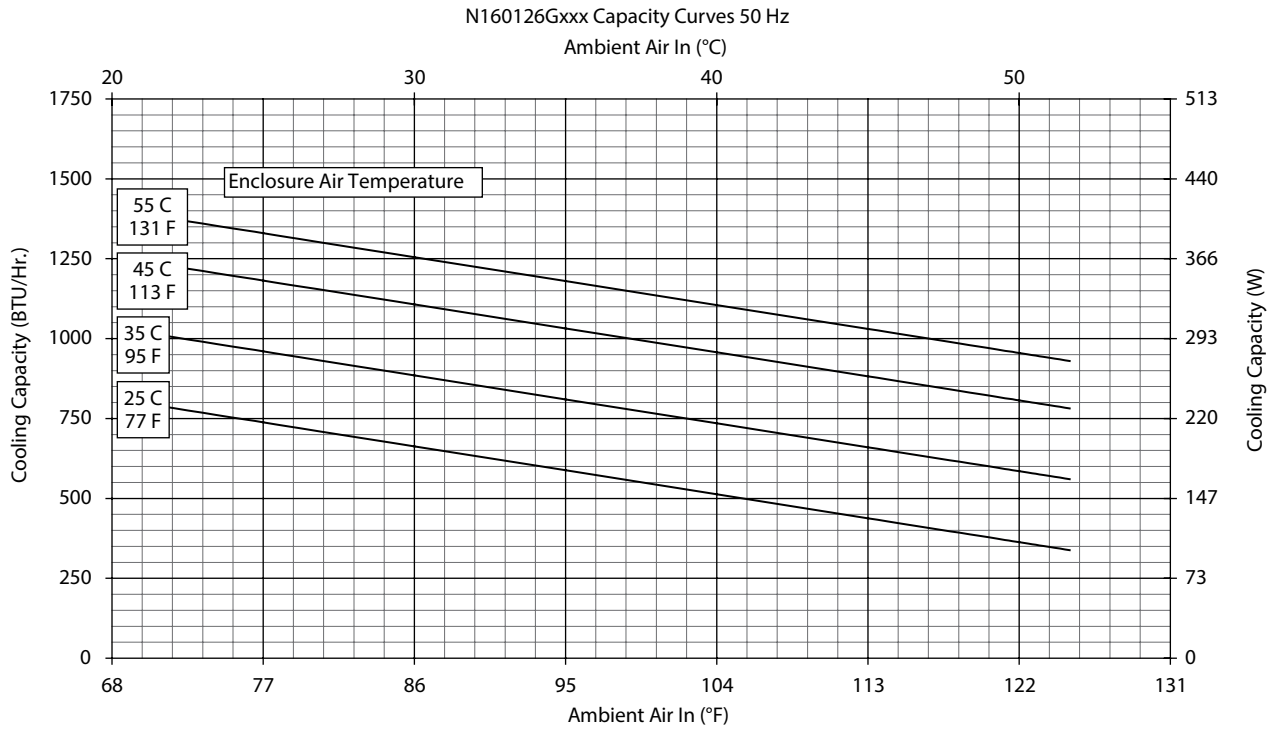

N16 800 BTU/Hr. (234 Watt)

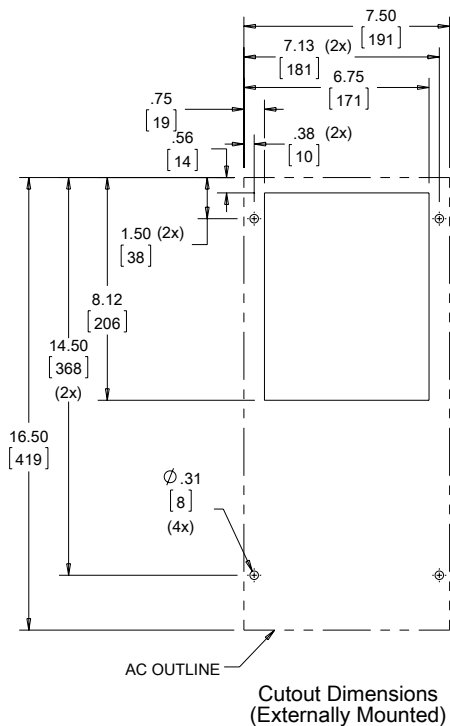
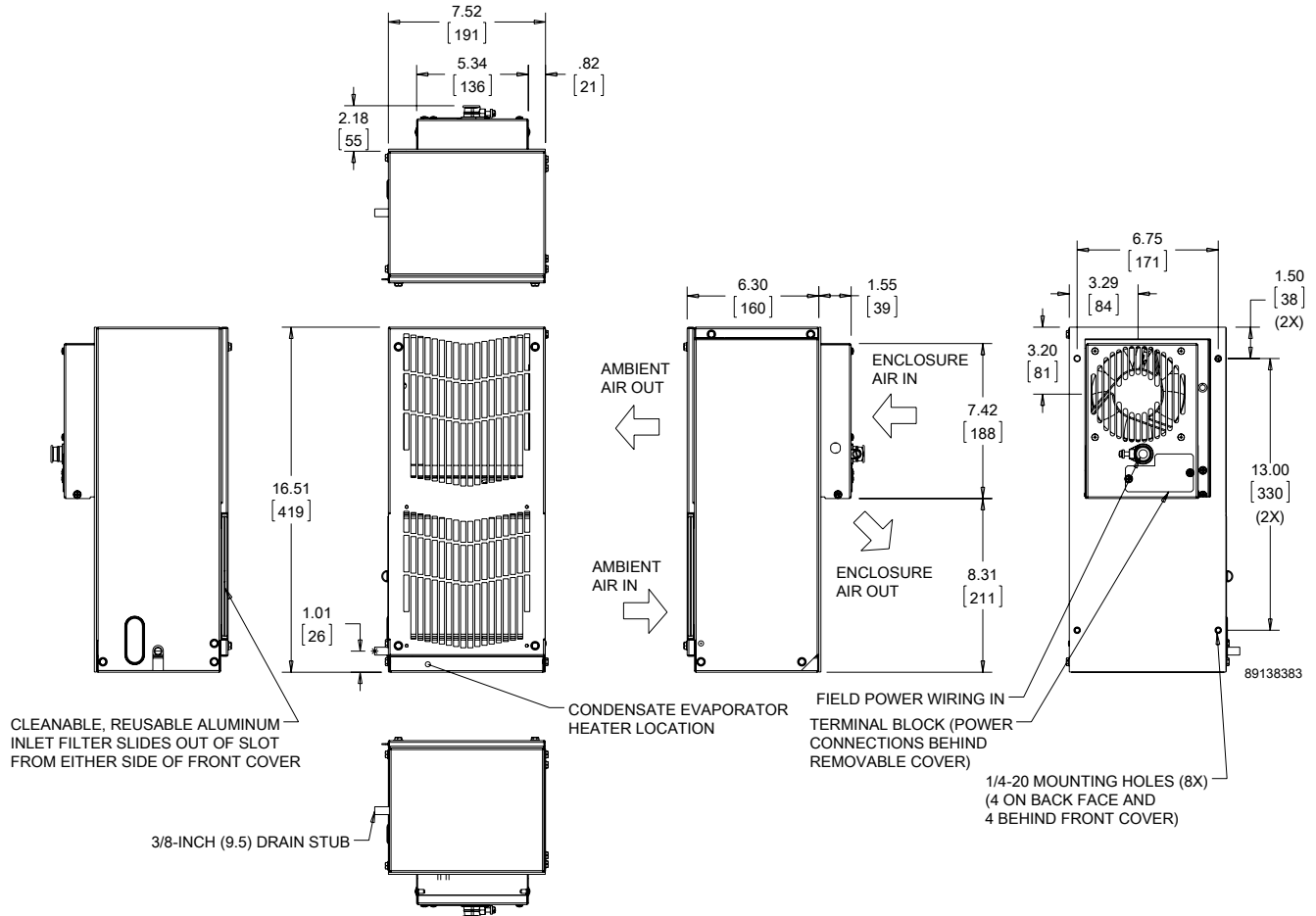

Visit www.nVent.com/HOFFMAN to download 2D and 3D CAD drawings into the overall design of your electrical system.

Performance Data N21 2000 BTU/Hr. (586 Watt) Models

CATALOG NUMBER			
Level 1 Painted Galvanized - G700	N210216G700	N210226G700	N210246G700
Level 1 Stainless Steel 316 - G102	N210216G102	N210226G102	N210246G102
Level 2 Painted Galvanized - G800	N210216G800	N210226G800	N210246G800
Level 2 Painted with Remote Access Control - G360*	N210216G360	N210226G360	N210246G360
Level 2 Stainless Steel 316 - G802	N210216G802	N210226G802	N210246G802
COOLING PERFORMANCE			
Nominal:**			
BTU/Hr.	2000	2000	2000
Watts	586	586	586
At 131 F/131 F (55 C/55 C):			
BTU/Hr. (50/60 Hz)	2000/2175	2000/2175	2000/2175
W (50/60 Hz)	586/637	586/637	586/637
At 95 F/95 F (35 C/35 C):			
BTU/Hr. (50/60 Hz)	1800/1975	1800/1900	1800/1900
W (50/60 Hz)	571/645	571/645	571/645
Refrigerant	R134A	R134A	R134A
Refrigerant Charge (ounces/grams)	6.5/184	6.5/184	6.5/184
Operating Temperature Range:			
Maximum (°F/°C)	131/55	131/55	131/55
Minimum (°F/°C)	-40/-40	-40/-40	-40/-40
Airflow at 0 Static Pressure:			
Internal loop 50 Hz (CFM / m ³ /hr.)	77/131	77/131	77/131
External loop 50 Hz (CFM / m ³ /hr.)	150/255	150/255	150/255
Internal loop 60 Hz (CFM / m ³ /hr.)	91/155	91/155	91/155
External loop 60 Hz (CFM / m ³ /hr.)	165/280	165/280	165/280
ELECTRICAL DATA			
Rated Voltage	115	230	460V 1PH
Frequency (Hz)	50/60	50/60	50/60
Operating Range	+/- 10%	+/- 10%	+/- 10%
Max. Power Consumption (W at 50/60 Hz)	700/805	805	874
Max. Nominal Current (A at 50/60 Hz)	7.2/7.2	3.6/3.6	1.9
Starting Current (A)	19	7.6	7.2
Agency Approvals		cUL Listed CE EAC	cUR Recognized CE EAC
Others available upon request			
Power Input Description	Terminal Block	Terminal Block	Terminal Block
ENCLOSURE PROTECTION			
UL Type	Type 12, 3R, 4 standard Type 4X Stainless steel optional		
CONTROLLER			
Description	Basic mechanical thermostat		
Thermostat Location	Enclosure side on all base models		
Factory Thermostat Setting (°F/°C)	80/2780/27		
SOUND LEVEL			
At 1.5 Meters	66 dB(A)		
UNIT DIMENSIONS			
Height (in./mm)	20.92/531	20.92/531	25.17/614
Width (in./mm)	10.00/254	10.00/254	10.00/254
Depth (in./mm)	9.90/251	9.90/251	9.90/251
Weight (lb./kg)	56/25	56/25	66/30

*Units with Remote Access Control utilize a digital controller and communicate via EtherNet/IP, Profinet, Modbus TCP/IP and SNMP over ethernet or modbus RTU over USB.

**Performance values are nominal. For actual values, see performance curves.

Performance Curves for N21 Models 2000 BTU/Hr. (586 Watt)

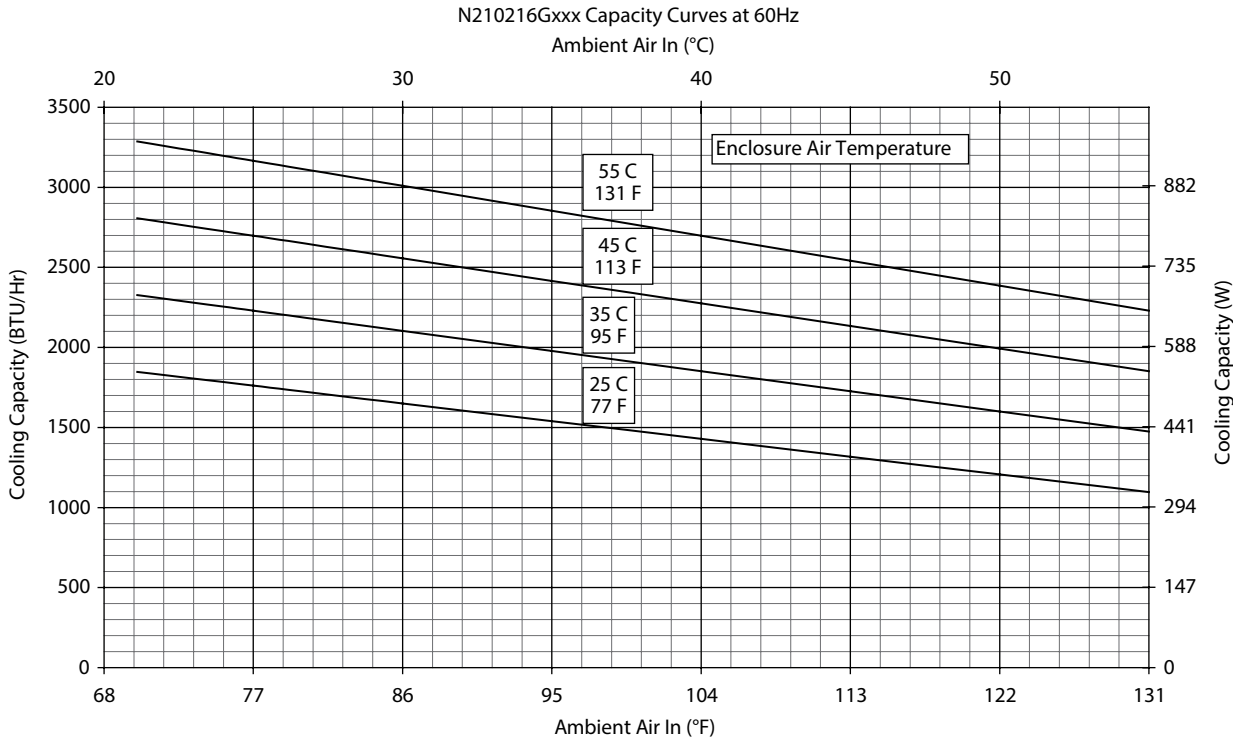
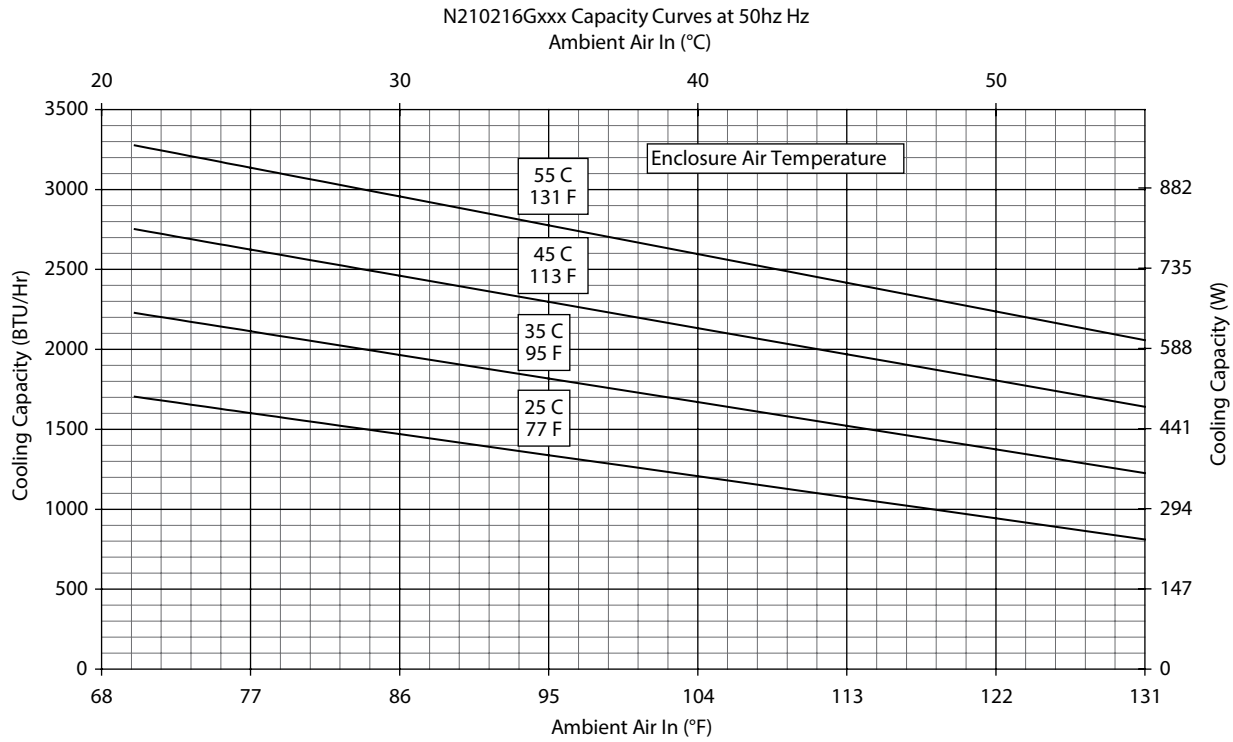

Performance Curves for N21 Models 2000 BTU/Hr. (586 Watt)

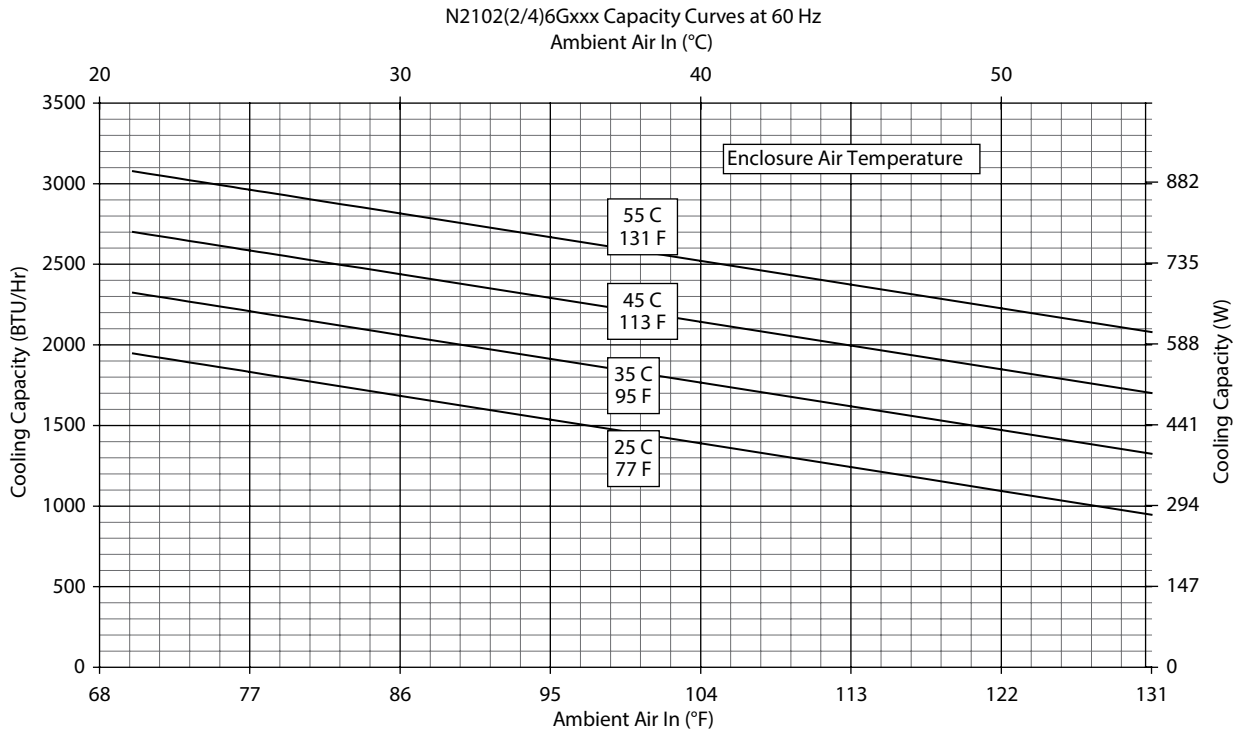
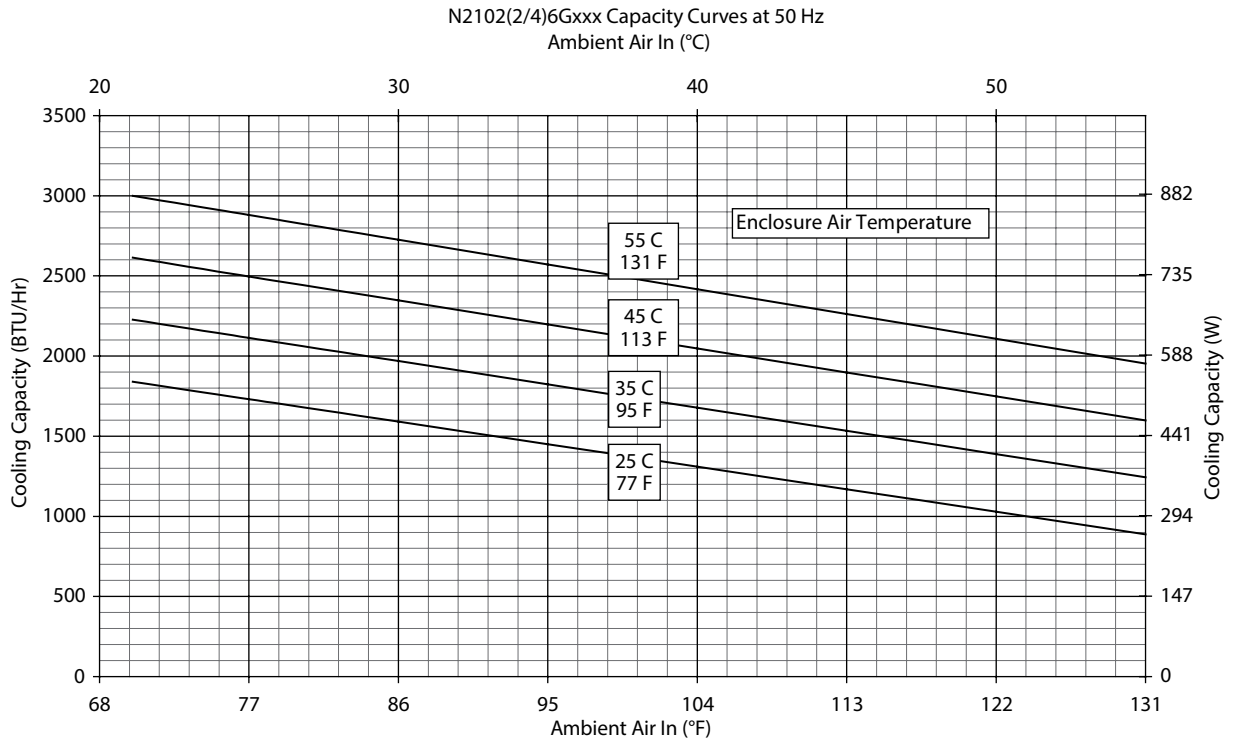

N21 115/230V Models 2000 BTU/Hr. (586 Watt)

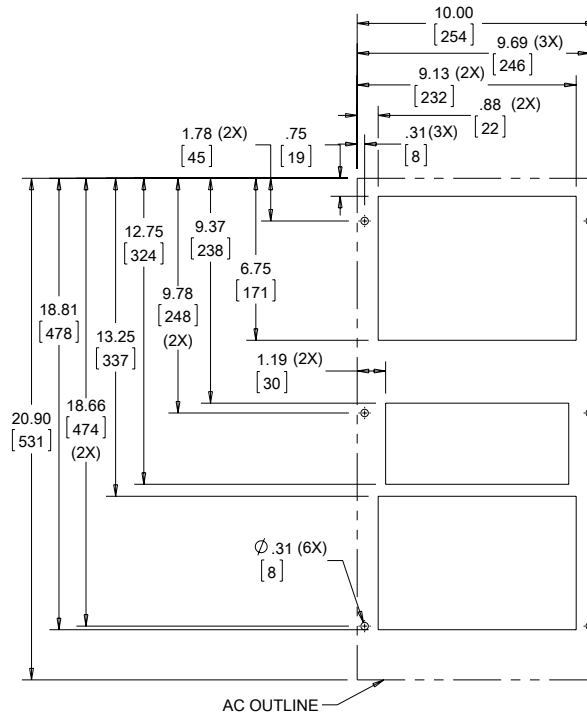
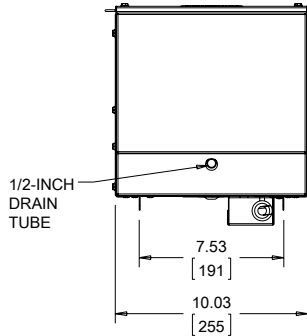
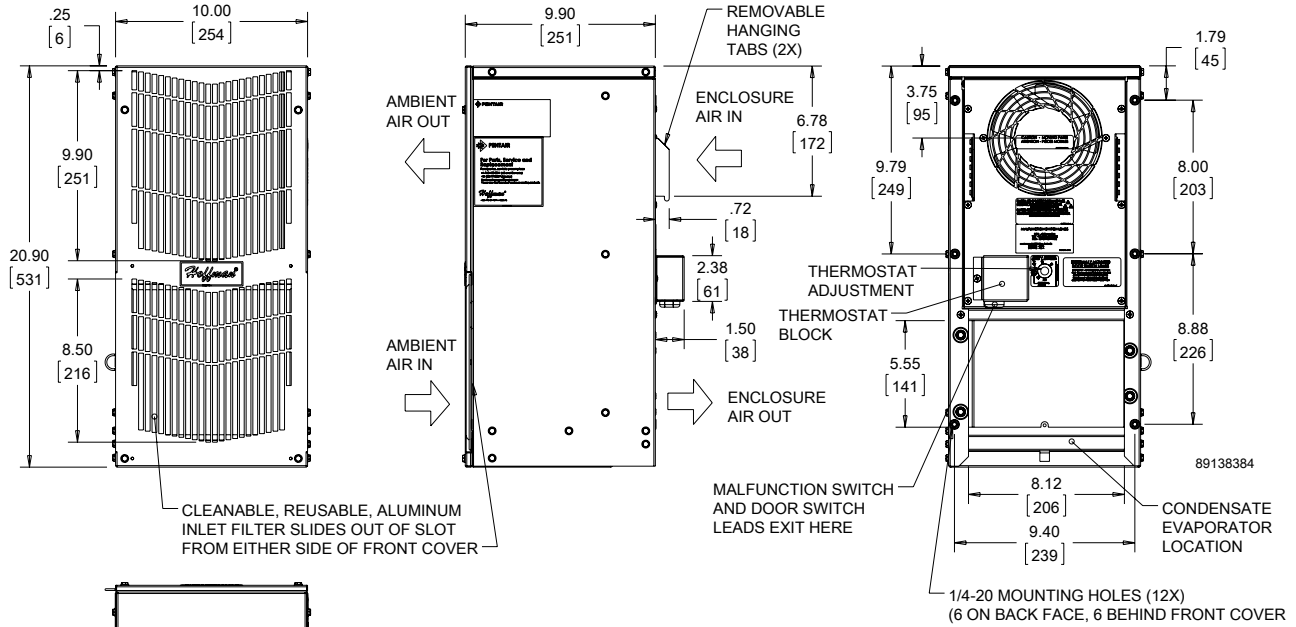

Cutout Dimensions (Externally Mounted)

Visit www.nVent.com/HOFFMAN to download 2D and 3D CAD drawings into the overall design of your electrical system.

N21 460V Models 2000 BTU/Hr. (586 Watt)

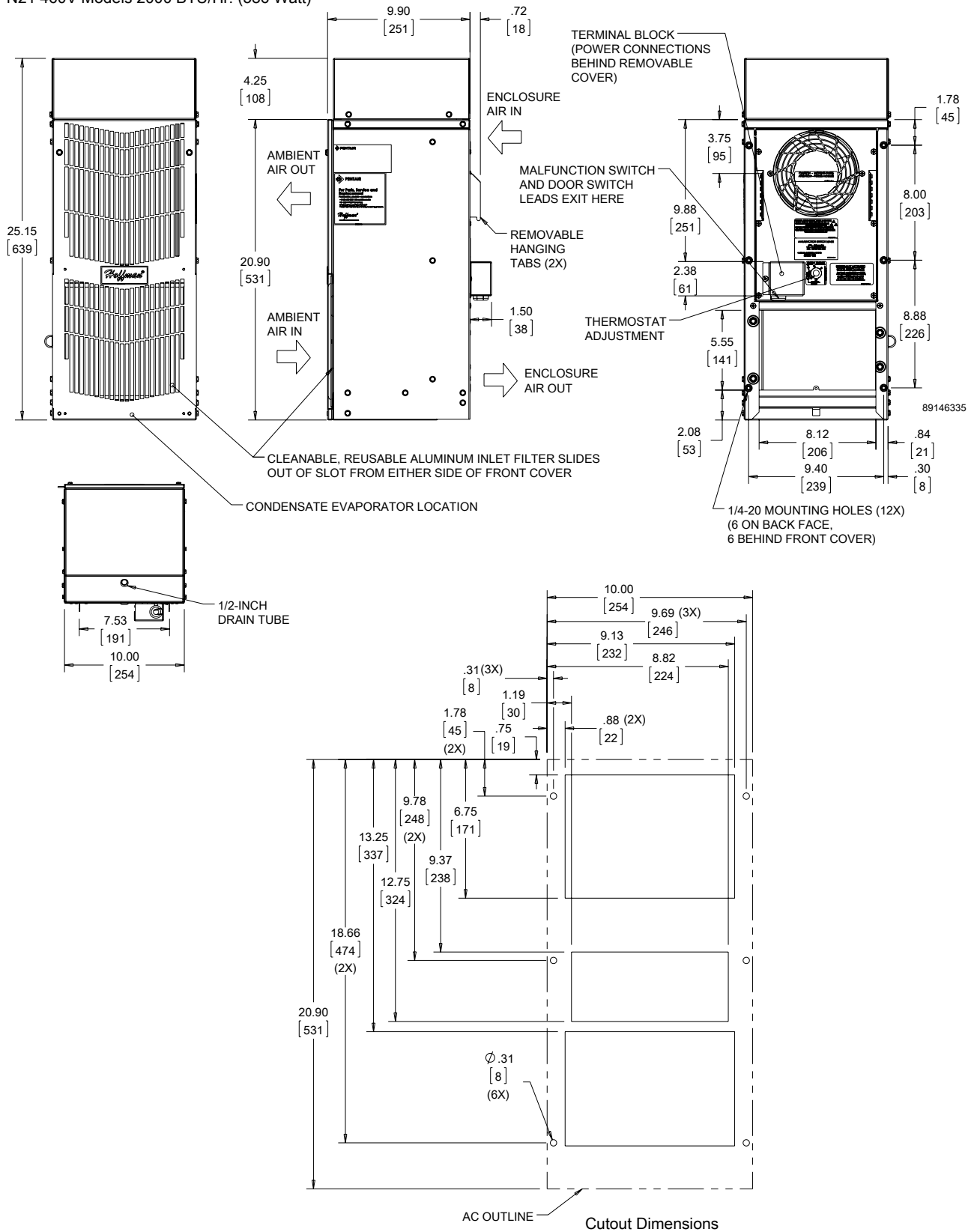

Visit www.nVent.com/HOFFMAN to download 2D and 3D CAD drawings into the overall design of your electrical system.

SPECTRACOOL NARROW WITH ADVANCED CORROSION PROTECTION



N43 11000 BTU/Hr. 3223 Watt	N36 6000/8000 BTU/Hr. 1758/2344 Watt	N28 4000 BTU/Hr. 1172 Watt
--	---	---

FEATURES

- Two levels of corrosion protection:
 - Level 1 - Protective coatings on all exposed copper tubing and solder joints, condenser coil and thermostat.
 - Level 2 - All protective coatings in Level 1 plus a coated evaporator coil. Foam wrap added over protective coatings on thermostat.
- Narrow design accommodates 12-in. (300-mm) deep cabinets
- Energy efficient reciprocating compressor on N28 models
- Energy efficient rotary compressor on N36 and N43 models
- R407c and R134a earth-friendly refrigerants
- Models for 115, 230 and 400/460 3-phase VAC power input
- UL Listed to save customers time and money with agency approvals
- Outdoor model operating temperature range from -40 F/-40 C to 131 F/55 C (125 F/52 C on N28 Series)
- Attractive industrial design with minimal use of visible fasteners
- Reliable mechanical thermostat on enclosure side of the unit; indoor Air Conditioner models include digital display on ambient side
- Galvanized sheet-metal cover for rugged factory and outdoor environments
- Easy-mount flanges for simple installation
- Cut-out adapter options for enclosures with GENESIS air conditioners enable users to easily transition to the new unit
- Dust-resistant condenser coil allows the unit to be run filterless in most applications
- Cleanable, reusable aluminum mesh filter protects coils for maximum cooling performance
- Mounting hardware, gaskets and user manual furnished with the unit
- Every unit functionally tested before shipping
- Standard models include:
 - Active condensate management with heater strip
 - Power-off relay for door switch and other system requirements
 - Malfunction switch
 - Telcordia GR-487 capable
 - Corrosion-resistant components
 - Malfunction switch
 - Compressor heater
 - Head pressure control

INDUSTRY STANDARDS

UL/cUL Listed; Type 12, 3R, 4; 4X optional; File No. SA6453

CE
 IP 56 Internal Loop
 IP 34 on External Loop
 Telcordia GR-487 capable (Outdoor)

APPLICATION

- Industrial automation
- Telecommunications equipment
- Waste water treatment systems
- Package handling equipment
- Security and defense systems
- Oil and gas
- Water treatment facilities
- Chemical manufacturing

SPECIFICATIONS

- Nominal cooling capacity:
 - N28 4000 BTU/Hr. (1172 W)
 - N36 6000 & 8000 BTU/Hr. (1758 and 2344 W)
 - N43 11000 BTU/Hr. (3223 W)
- Outdoor model operating temperature range from -40 F/-40 C to 131 F/55 C (125 F/52 C on N28 Series)

FINISH

- RAL 7035 light-gray, semi-textured powder-coat paint
- No. 4 brushed 316 stainless steel
- Other colors and textures available

NOTES

Visit <http://hoffman.nvent.com/en/hoffman/SPECTRACOOL-Remote-Access-Control-472042> for more information regarding SPECTRACOOL Remote Access Control (RAC).

Visit <https://hoffman.nvent.com/en/hoffman/thermal-management> to download 2D and 3D CAD drawings into the overall design of your electrical system.



Performance Data N28 4000 BTU/Hr. (1172 Watt)

CATALOG NUMBER			
Level 1 Painted Galvanized - G700	N280416G700	N280426G700	N280446G700
Level 1 Stainless Steel 316 - G102	N280416G102	N280426G102	N280446G102
Level 2 Painted Galvanized - G800	N280416G800	N280426G800	N280446G800
Level 2 Painted with Remote Access Control - G360*	N280416G360	N280426G360	N280446G360
Level 2 Stainless Steel 316 - G802	N280416G802	N280426G802	N280446G802
COOLING PERFORMANCE			
Nominal:**			
BTUs/Hr.	4000	4000	4000
Watts	1172	1172	1172
At 125 F / 125 F (50 C / 50 C):			
BTU/Hr. (50 / 60 Hz)	3940 / 4104	4269 / 4703	4269 / 4703
Watts (50 / 60 Hz)	1150 / 1000	1250 / 1378	1250 / 1378
At 95 F / 95 F (35 C / 35 C):			
BTU/Hr. (50 / 60 Hz)	3754 / 4011	3700 / 4291	3700 / 4291
Watts (50 / 60 Hz)	1100 / 1175	1086 / 1257	1086 / 1257
Refrigerant	R134a	R134a	R134a
Refrigerant Charge (ounces/grams)	10 / 283	11 / 312	11 / 312
Operating Temperature Range:			
Maximum (°F / °C)	125 / 52	125 / 52	125 / 52
Minimum (°F / °C)	-40 / -40	-40 / -40	-40 / -40
Air Flow at 0 Static Pressure:			
Internal loop 50 Hz (CFM / M ³ /Hr)	138 / 234	138 / 234	138 / 234
External loop 50 Hz (CFM / M ³ /Hr)	268 / 455	268 / 455	268 / 455
Internal loop 60 Hz (CFM / M ³ /Hr)	143 / 243	143 / 243	143 / 243
External loop 60 Hz (CFM / M ³ /Hr)	288 / 489	288 / 489	288 / 489
ELECTRICAL DATA			
Rated Voltage	110 / 115	230	460V 1PH
Frequency (Hz)	50 / 60	50 / 60	50 / 60
Operating Range	+/-10%	+/-10%	+/-10%
Max. Power Consumption (Watts at 50 / 60 Hz)	971 / 1116	975 / 1104	1104
Max. Nominal Current (Amps at 50 / 60 Hz)	10.1/11.2	4.9/5.0	2.5
Starting Current (Amps)	40	24.5	12.5
Agency Approvals		cUL Listed CE	
Power Input Description		Others available upon request Terminal Block	
ENCLOSURE PROTECTION			
UL Type		Type 12, 3R, 4 Standard Type 4X Stainless Steel Optional	
CONTROLLER			
Description		Basic Mechanical Thermostat	
Thermostat Location		Enclosure Side	
Factory Thermostat Setting (°F / °C)		80 / 27	
SOUND LEVEL			
At 1.5 Meters	64.4 dBA	65.5 dBA	65.5 dBA
ACCESSORIES			
EASYSWAP Adaptor Plenum (GENESIS M33)		Enables SPECTRACOOOL to be mounted to a GENESIS M33 air conditioner cutout Catalog Number PLM33N28	
UNIT DIMENSIONS			
Height (in / mm)		28 / 711.2	
Width (in / mm)		11.50 / 292.1	
Depth (in / mm)		14.00 / 355.6	
Weight (lb / kg)	84 / 38	84 / 38	92 / 41.7

*Units with Remote Access Control utilize a digital controller and communicate via EtherNet/IP, Profinet, Modbus TCP/IP and SNMP over ethernet or modbus RTU over USB.

**Performance values are nominal. For actual values, see performance curves.

Performance Curves for N28 Models 4000 BTU/Hr. (1172 Watt)

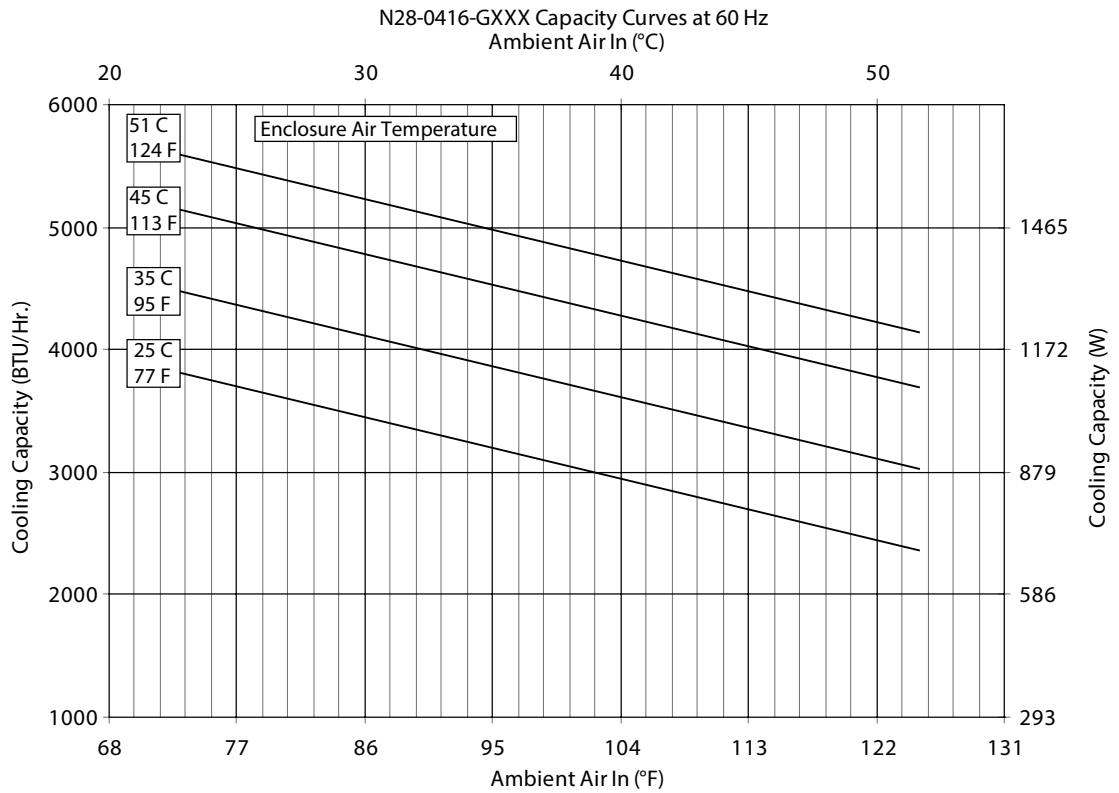
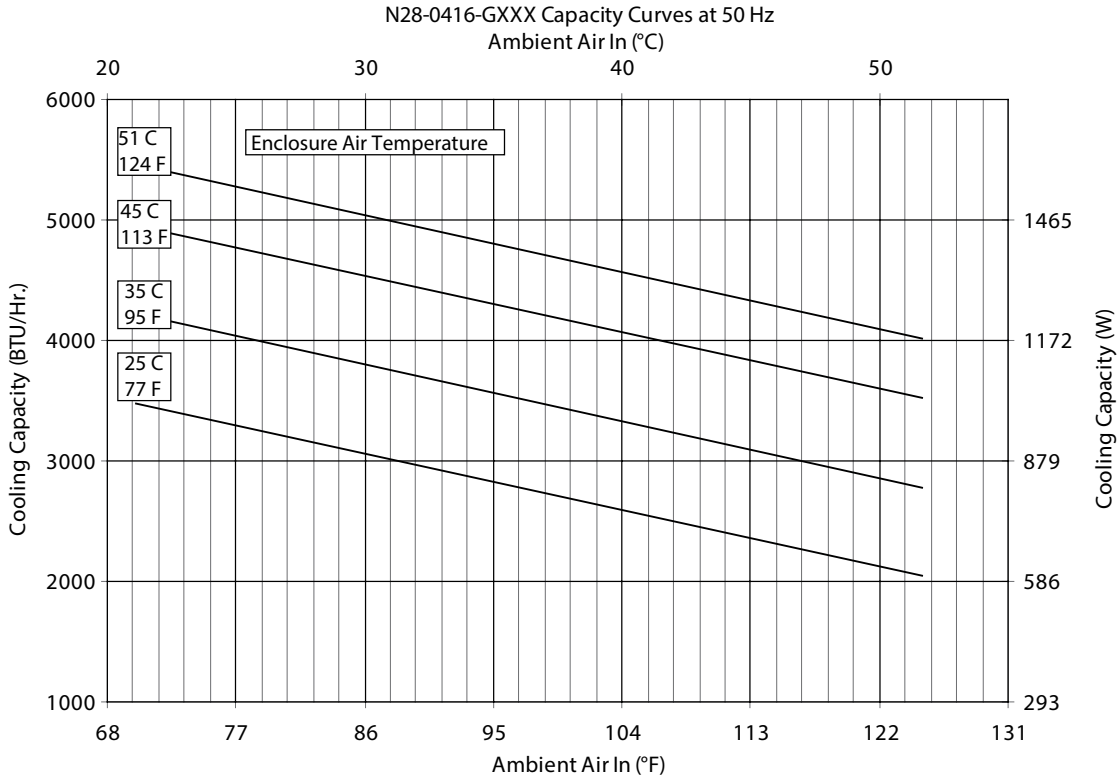

Performance Curves for N28 Models 4000 BTU/Hr. (1172 Watt)

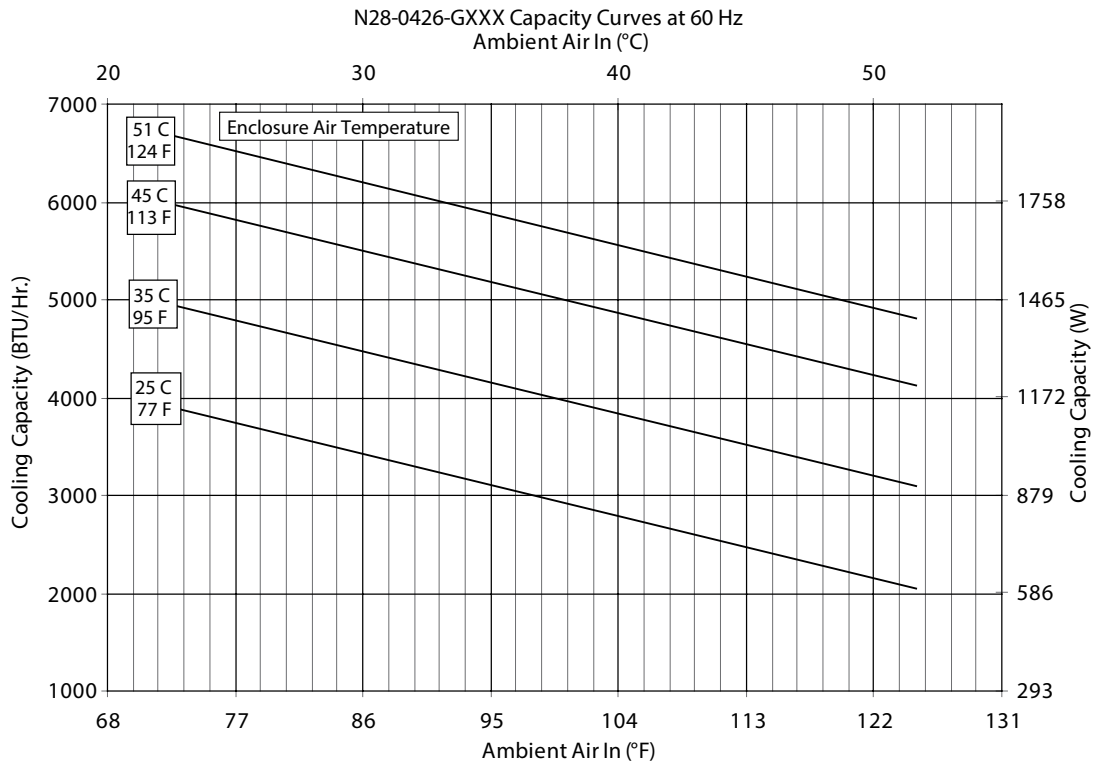
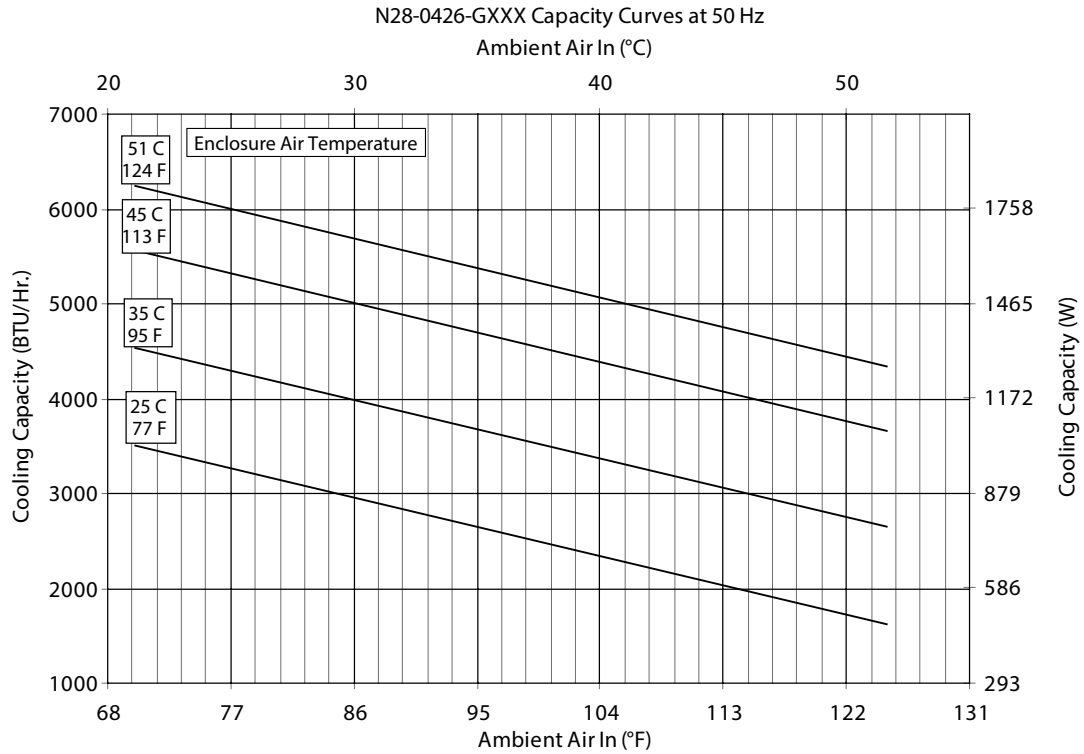

N28 Models 4000 BTU/Hr. (1172 Watt)

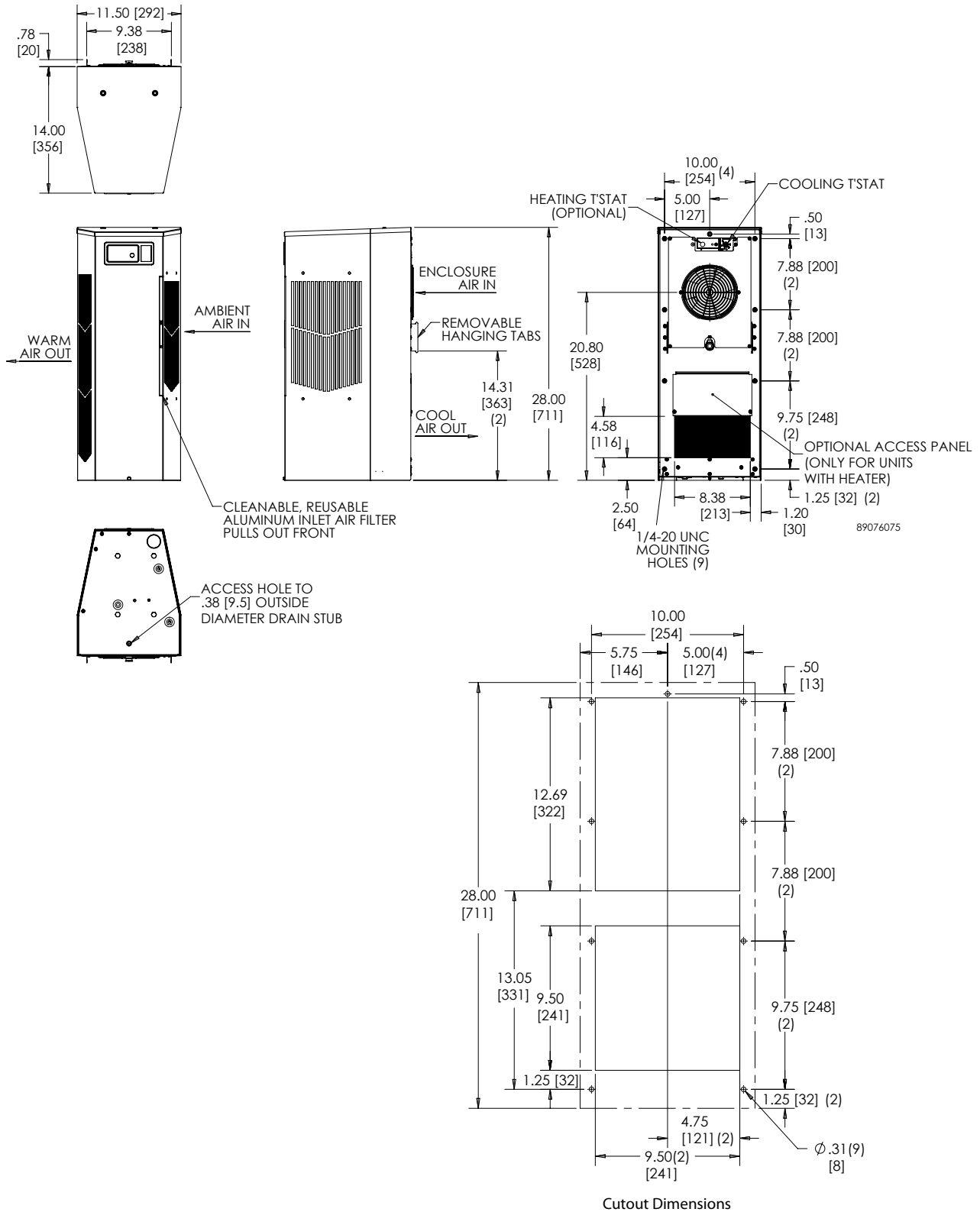

Visit www.nVent.com/HOFFMAN to download 2D and 3D CAD drawings into the overall design of your electrical system.

Performance Data N36 6000/8000 BTU/Hr. (1758/2344 Watt)

CATALOG NUMBER						
Level 1 Painted Galvanized - G700	N360616G700	N360626G700	N360646G700	N360816G700	N360826G700	N360846G700
Level 1 Stainless Steel 316 - G102	N360616G102	N360626G102	N360646G102	N360816G102	N360826G102	N360846G102
Level 2 Painted Galvanized - G800	N360616G800	N360626G800	N360646G800	N360816G800	N360826G800	N360846G800
Level 2 Painted with Remote Access Control - G360*	N360616G360	N360626G360	N360646G360	N360816G360	N360826G360	N360846G360
Level 2 Stainless Steel 316 - G802	N360616G802	N360626G802	N360646G802	N360816G802	N360826G802	N360846G802
COOLING PERFORMANCE						
Nominal:**						
BTU/Hr.	6000	6000	6000	8000	8000	8000
Watts	1757	1757	1757	2344	2344	2344
At 131 F / 131 F (55 C / 55 C):						
BTU/Hr. (50 / 60 Hz)	5639/6217	5771 / 6410	5300 / 6089	7074 / 7754	7400 / 8000	7311 / 7940
Watts (50 / 60 Hz)	1653/1822	1691 / 1879	1553 / 1785	2073 / 2272	2169 / 2345	2143 / 2327
At 95 F / 95 F (35 C / 35 C):						
BTU/Hr. (50 / 60 Hz)	5104/5654	5613 / 5647	5572 / 6026	6248 / 6739	7444 / 7955	6448 / 6716
Watts (50 / 60 Hz)	1496/1657	1645 / 1655	1633 / 1766	1831 / 1975	2182 / 2331	1890 / 1968
Refrigerant	R134a	R134a	R134a	R134a	R134a	R134a
Refrigerant Charge (ounces/grams)	20 / 567	22 / 624	16 / 454	27 / 765	32 / 907	33 / 936
Operating Temperature Range:						
Maximum (°F / °C)	131 / 55	131 / 55	131 / 55	131 / 55	131 / 55	131 / 55
Minimum (°F / °C)	-40 / -40	-40 / -40	-40 / -40	-40 / -40	-40 / -40	-40 / -40
Air Flow at 0 Static Pressure:						
Internal loop 50 Hz (CFM / M ³ /Hr.)	251 / 426	250 / 425	250 / 425	250 / 425	245 / 416	243 / 413
External loop 50 Hz (CFM / M ³ /Hr.)	284 / 483	338 / 574	338 / 574	353 / 600	347 / 589	365 / 620
Internal loop 60 Hz (CFM / M ³ /Hr.)	261 / 443	261 / 443	261 / 443	263 / 447	258 / 439	254 / 432
External loop 60 Hz (CFM / M ³ /Hr.)	311 / 528	356 / 605	356 / 605	396 / 673	382 / 648	394 / 669
ELECTRICAL DATA						
Rated Voltage	115	230	400 / 460 3~	115	230	400 / 460 3~
Frequency (Hz)	50 / 60	50 / 60	50 / 60	50 / 60	50 / 60	50 / 60
Operating Range	+/-10%	+/-10%	+/-10%	+/-10%	+/-10%	+/-10%
Max. Power Consumption (Watts at 50 / 60 Hz)	914/1074	949 / 1097	697 / 895	1100 / 1333	1199 / 1476	1327 / 1647
Max. Nominal Current (Amps at 50 / 60 Hz)	8.6/9.4	4.7 / 5.0	1.59 / 1.69	9.9 / 11.6	5.1 / 6.6	3.0 / 3.3
Starting Current (Amps)	39.5	21.0	8.1	38.0	19.0	16.0
Agency Approvals				cUL Listed CE		
Power Input Description				Others available upon request		
ENCLOSURE PROTECTION				Terminal Block		
UL Type				Type 12, 3R, 4 Standard Type 4X Stainless Steel Optional		
CONTROLLER						
Description				Basic Mechanical Thermostat		
Thermostat Location				Enclosure Side		
Factory Thermostat Setting (°F / °C)				80 / 27		
SOUND LEVEL						
At 1.5 Meters	66.9 dBA	66.7 dBA	68.2 dBA	74.5 dBA	66.0 dBA	66.0 dBA
ACCESSORIES						
EASYSWAP Adaptor Plenum (GENESIS M36)				Enables SPECTRACOOL to be mounted to a GENESIS M36 air conditioner cutout Catalog Number PLM36N36		
UNIT DIMENSIONS						
Height (in. / mm)				36.00 / 914.4		
Width (in. / mm)				11.50 / 292.1		
Depth (in. / mm)				14.00 / 355.6		
Weight (lb. / kg)	100 / 45	100 / 45	104 / 47	106 / 48	106 / 48	114 / 52

*Units with Remote Access Control utilize a digital controller and communicate via EtherNet/IP, Profinet, Modbus TCP/IP and SNMP over ethernet or modbus RTU over USB.

**Performance values are nominal. For actual values, see performance curves.

Performance Curves for N36 Models 6000 BTU/Hr. (1758 Watt)

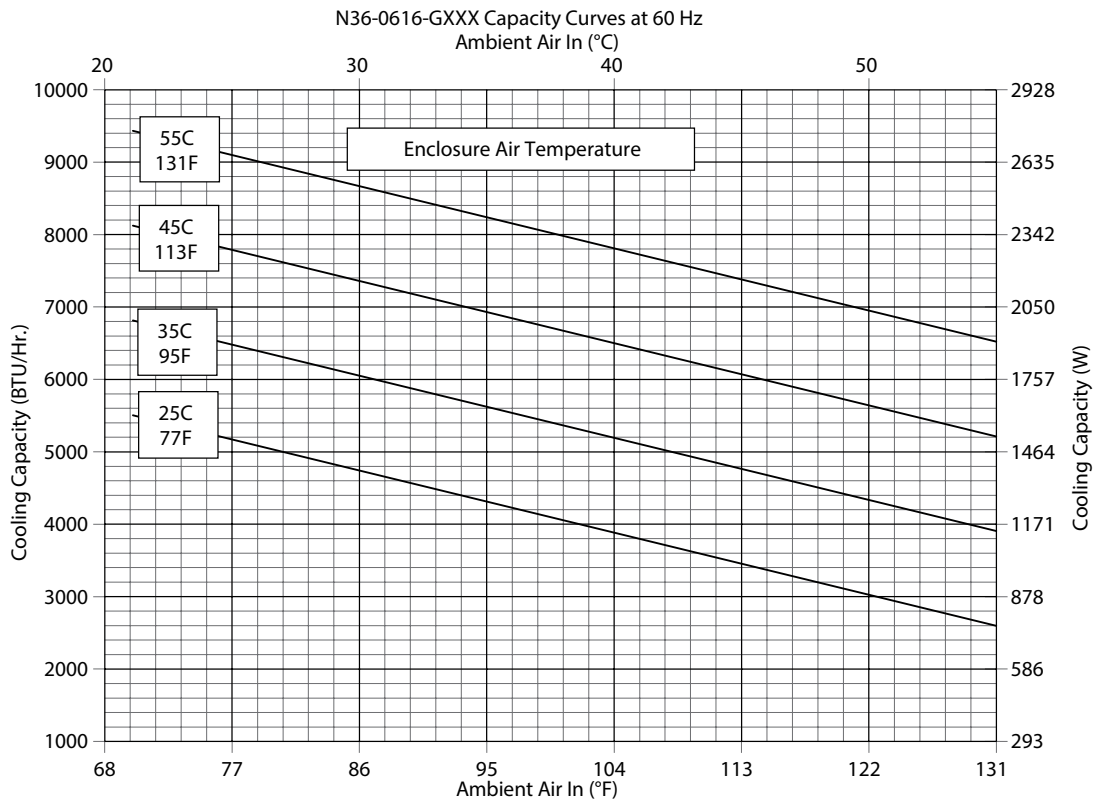
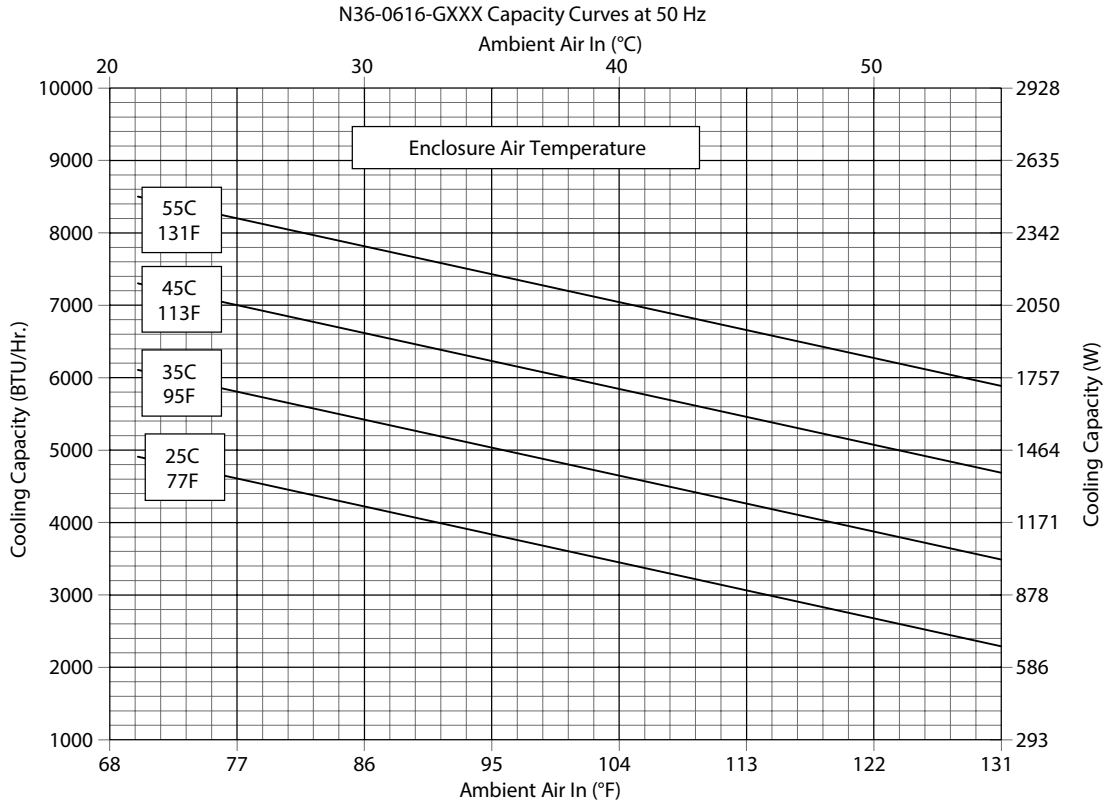

Performance Curves for N36 Models 6000 BTU/Hr. (1758 Watt)

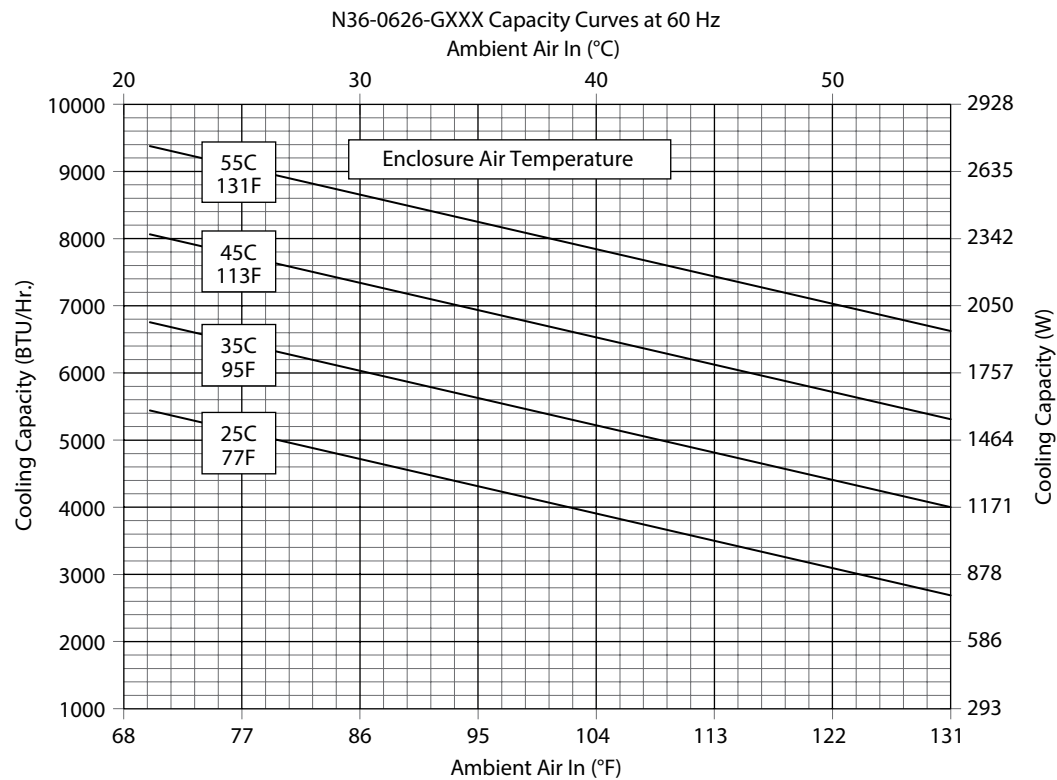
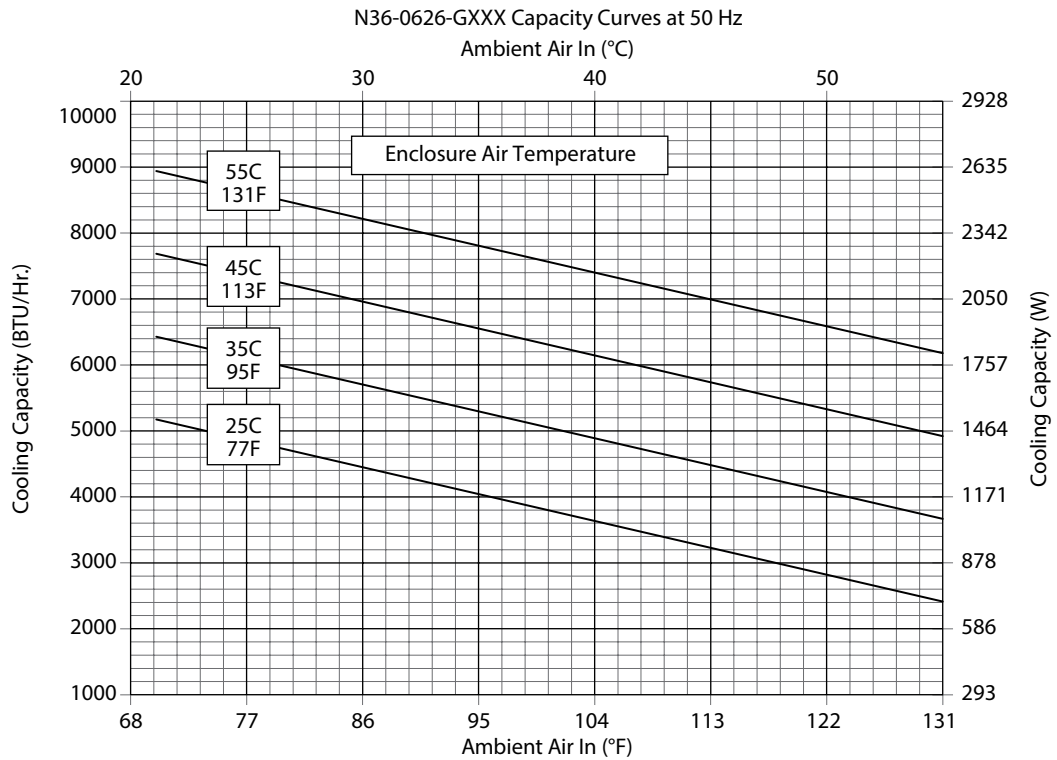

Performance Curves for N36 Models 6000 BTU/Hr. (1758 Watt)

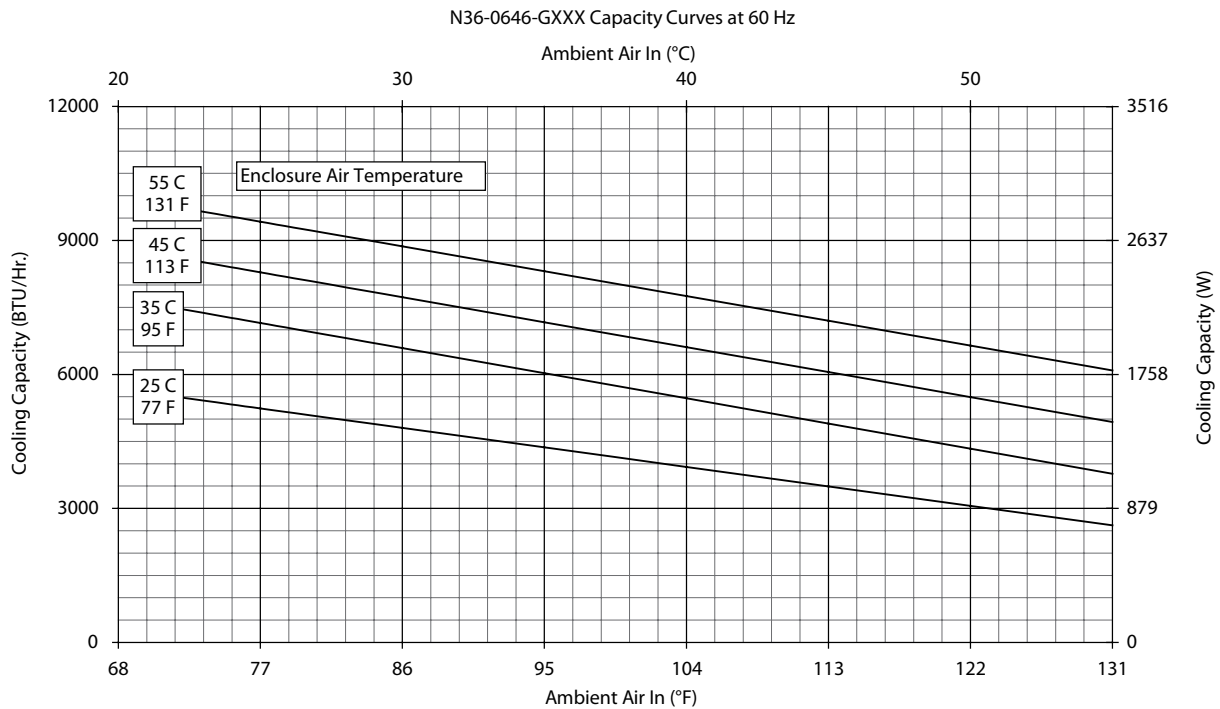
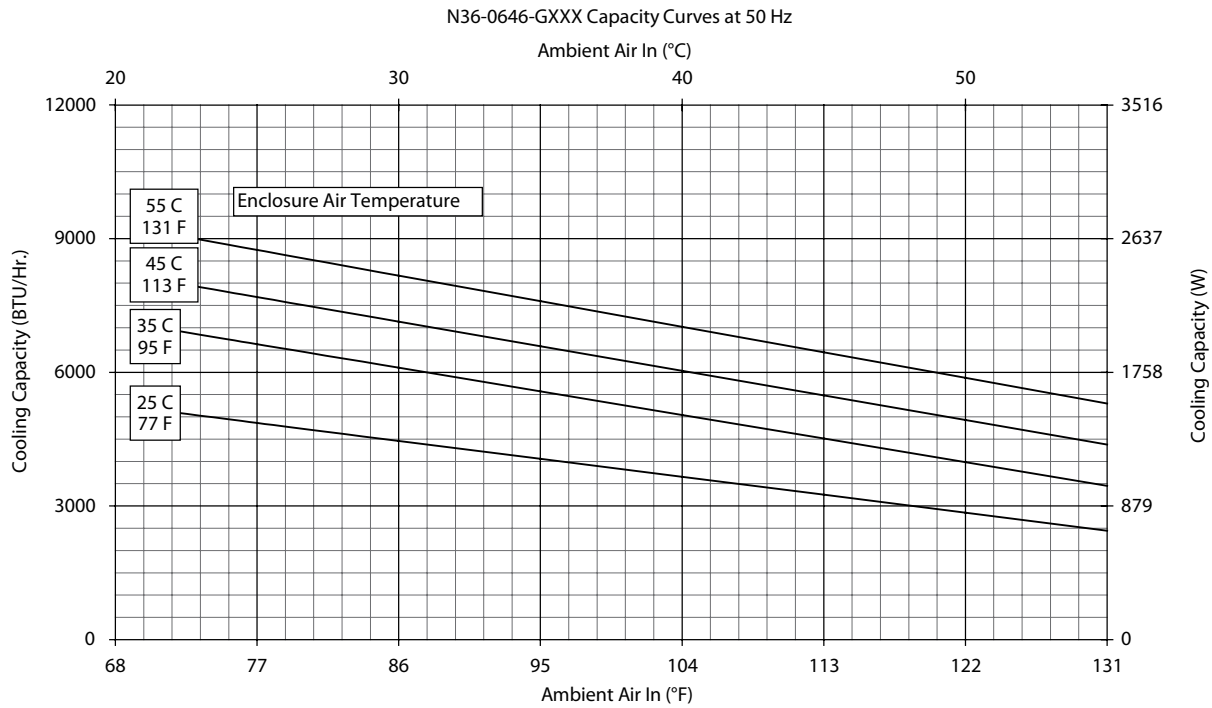

Performance Curves for N36 Models 8000 BTU/Hr. (2344 Watt)

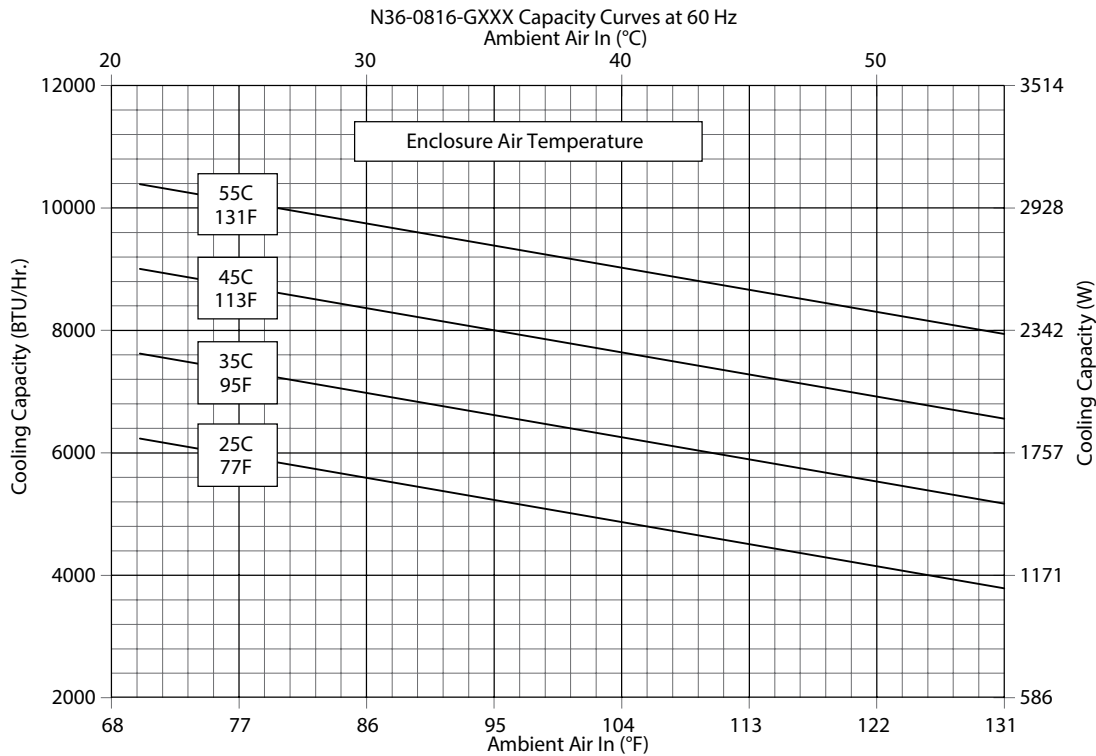
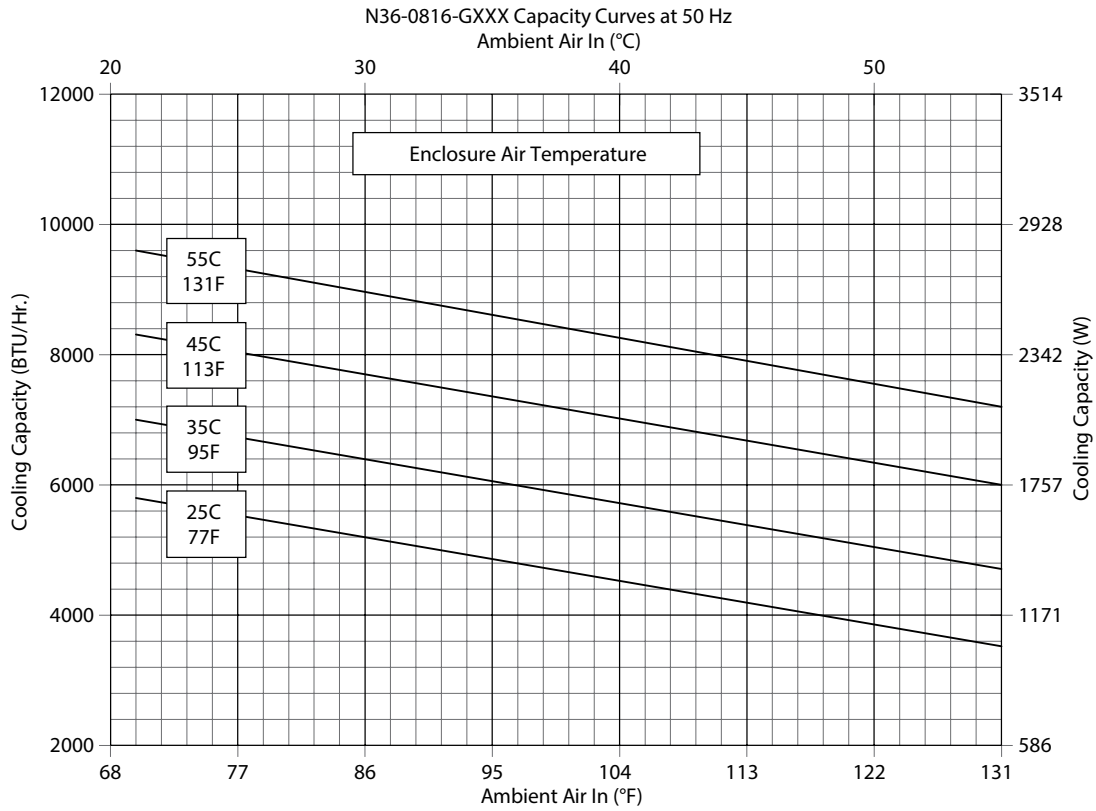

Performance Curves for N36 Models 8000 BTU/Hr. (2344 Watt)

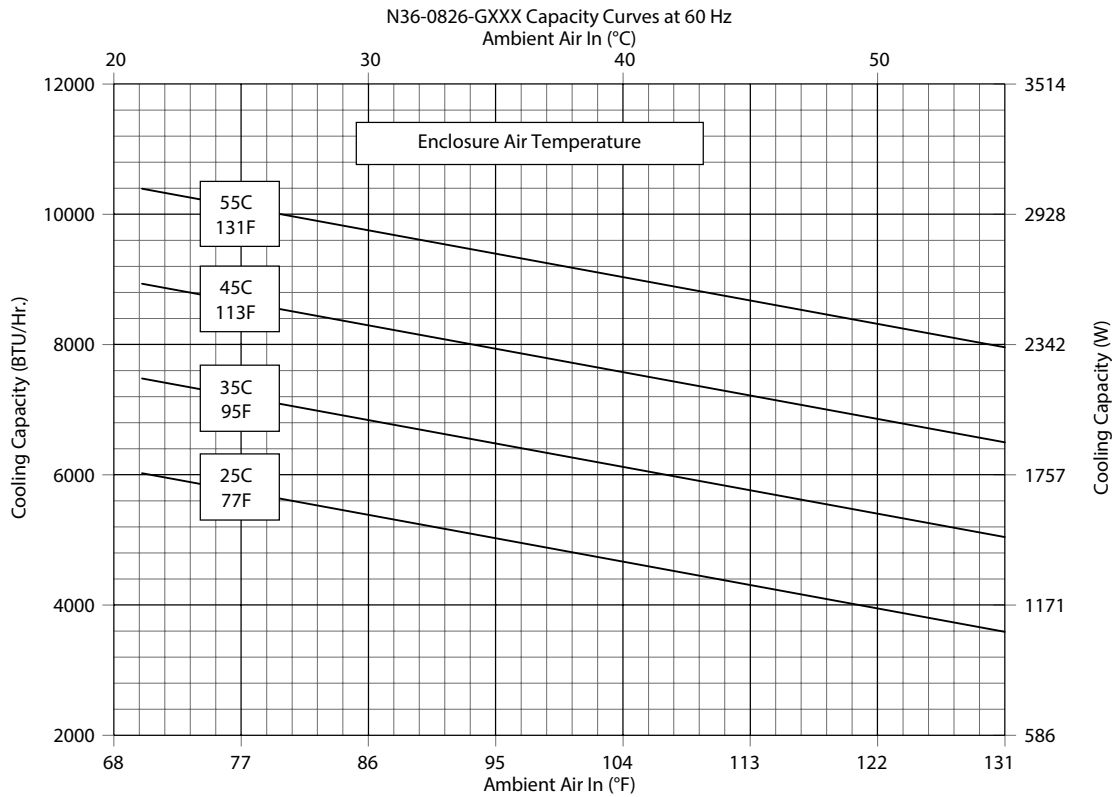
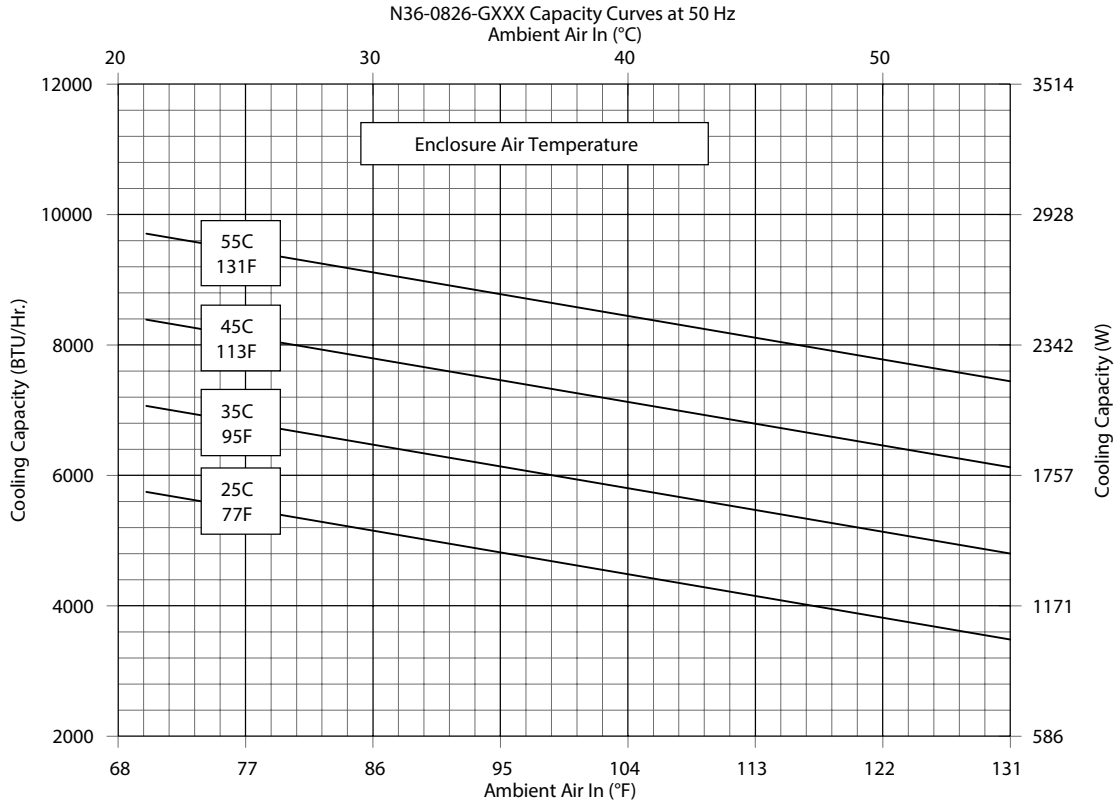

Performance Curves for N36 Models 8000 BTU/Hr. (2384 Watt)

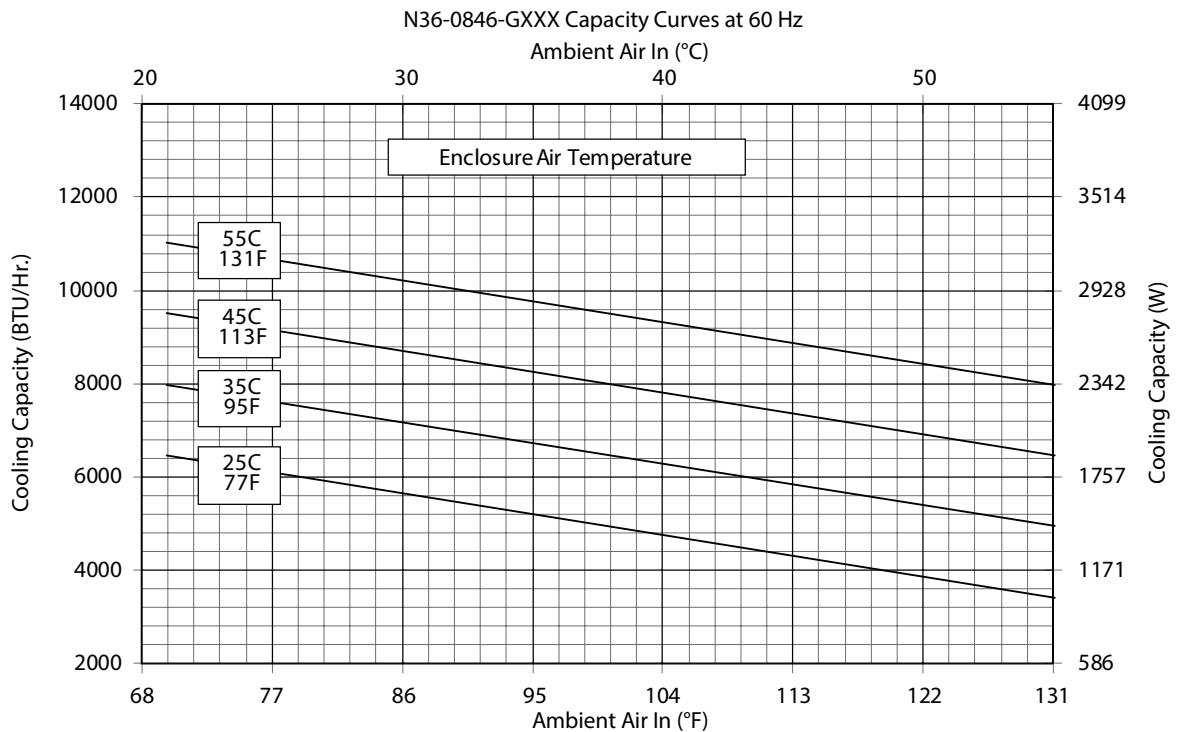
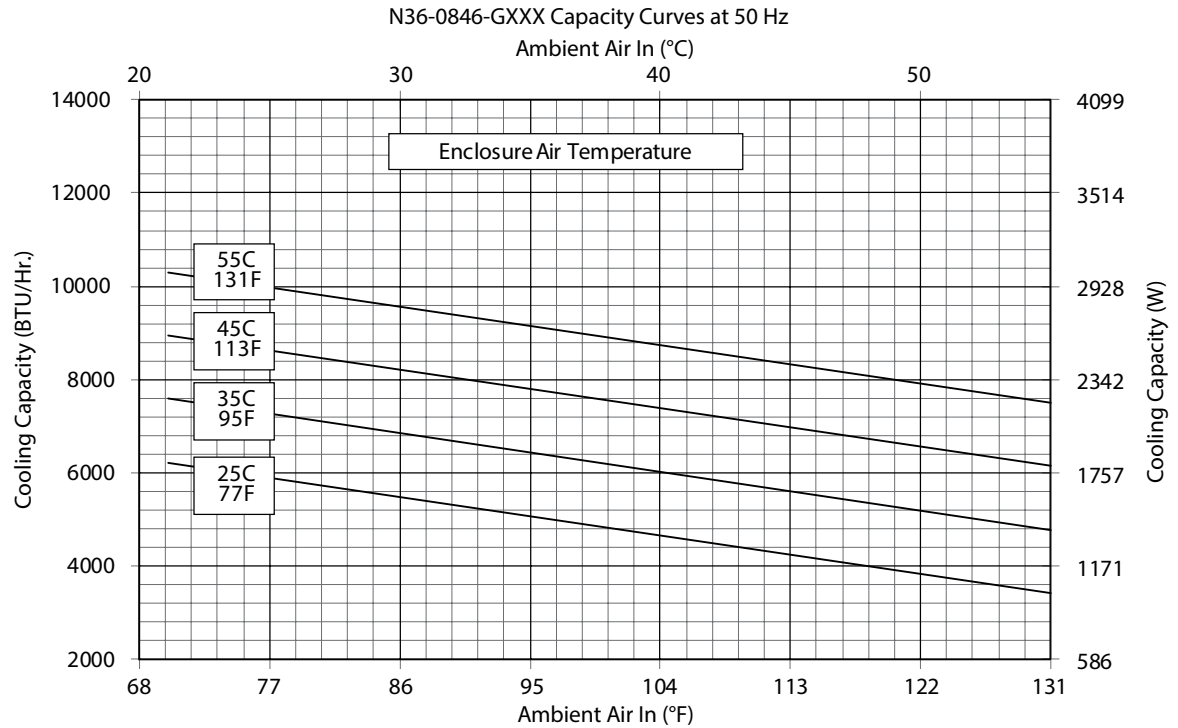

N36 6000/8000 BTU/Hr. (1758/2344 Watt)

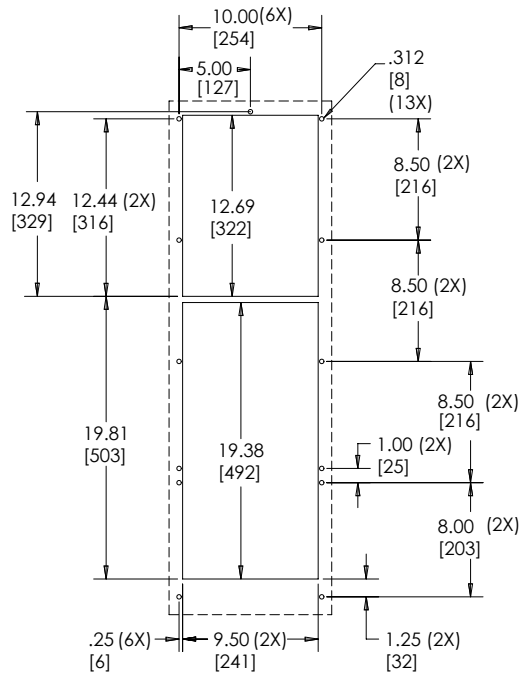
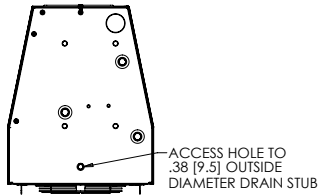
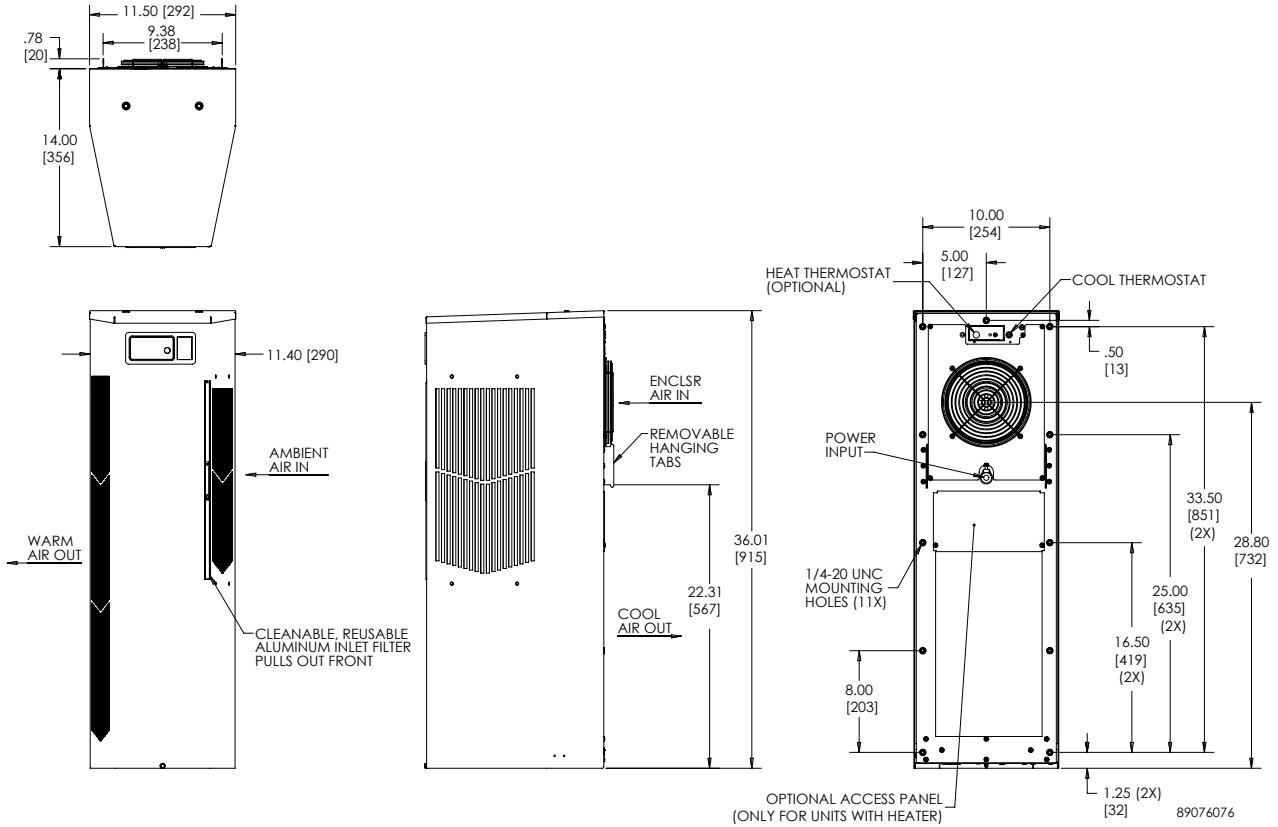

Cutout Dimensions

Visit www.nVent.com/HOFFMAN to download 2D and 3D CAD drawings into the overall design of your electrical system.

Performance Data N43 11000 BTU/Hr. (3223 Watt)

CATALOG NUMBER			
Level 1 Painted Galvanized - G700	N431216G700	N431226G700	N431246G700
Level 1 Stainless Steel 316 - G102	N431216G102	N431226G102	N431246G102
Level 2 Painted Galvanized - G800	N431216G800	N431226G800	N431246G800
Level 2 Painted with Remote Access Control - G360*	N431216G360	N431226G360	N431246G360
Level 2 Stainless Steel 316 - G802	N431216G802	N431226G802	N431246G802
COOLING PERFORMANCE			
Nominal:**			
BTU/Hr.	11000	11000	11000
Watts	3223	3223	3223
At 131 F / 131 F (55 C / 55 C):			
BTU/Hr. (50 / 60 Hz)	9555/10793	9664/10420	9669/10463
Watts (50 / 60 Hz)	2800/3163	2832/3054	2834/3066
At 95 F / 95 F (35 C / 35 C):			
BTU/Hr. (50 / 60 Hz)	8875/10044	8713/9232	8352/9322
Watts (50 / 60 Hz)	2601/2944	2554/2706	2448/2732
Refrigerant	R134a	R134a	R134a
Refrigerant Charge (ounces/grams)	36 / 1021	39/1106	43/1219
Operating Temperature Range:			
Maximum (°F / °C)	131 / 55	131 / 55	131 / 55
Minimum (°F / °C)	-40 / -40	-40 / -40	-40 / -40
Air Flow at 0 Static Pressure:			
Internal loop 50 Hz (CFM / M ³ /Hr)	239 / 406	259 / 440	254 / 432
External loop 50 Hz (CFM / M ³ /Hr)	494 / 839	489 / 831	341 / 579
Internal loop 60 Hz (CFM / M ³ /Hr)	250 / 425	267 / 454	260 / 442
External loop 60 Hz (CFM / M ³ /Hr)	528 / 897	525 / 892	564 / 958
ELECTRICAL DATA			
Rated Voltage	115	230	400 / 460 3~
Frequency (Hz)	50 / 60	50 / 60	50 / 60
Operating Range	+/-10%	+/-10%	+/-10%
Max. Power Consumption (Watts at 50 / 60 Hz)	1741/2260	1762/2226	1678/2107
Max. Nominal Current (Amps at 50 / 60 Hz)	16.2/20.8	7.9/10.2	3.4/3.6
Starting Current (Amps)	60	30/28	20/18
Agency Approvals		cUL Listed CE	
Power Input Description		Others available upon request	
ENCLOSURE PROTECTION		Terminal Block	
UL Type		Type 12, 3R, 4 Standard Type 4X Stainless Steel Optional	
CONTROLLER			
Description		Basic Mechanical Thermostat	
Thermostat Location		Enclosure Side	
Factory Thermostat Setting (°F / °C)		80 / 27	
SOUND LEVEL			
At 1.5 Meters	68.4 dBA	68.4 dBA	69.6 dBA
UNIT DIMENSIONS			
Height (in / mm)		43.00 / 1092.2	
Width (in / mm)		11.50 / 292.1	
Depth (in / mm)		14.00 / 355.6	
Weight (lb / kg)	127/57.6	127/57.6	138/62.6

*Units with Remote Access Control utilize a digital controller and communicate via EtherNet/IP, Profinet, Modbus TCP/IP and SNMP over ethernet or modbus RTU over USB.

**Performance values are nominal. For actual values, see performance curves.

Performance Curves for N43 Models 11000 BTU/Hr. (3223 Watt)

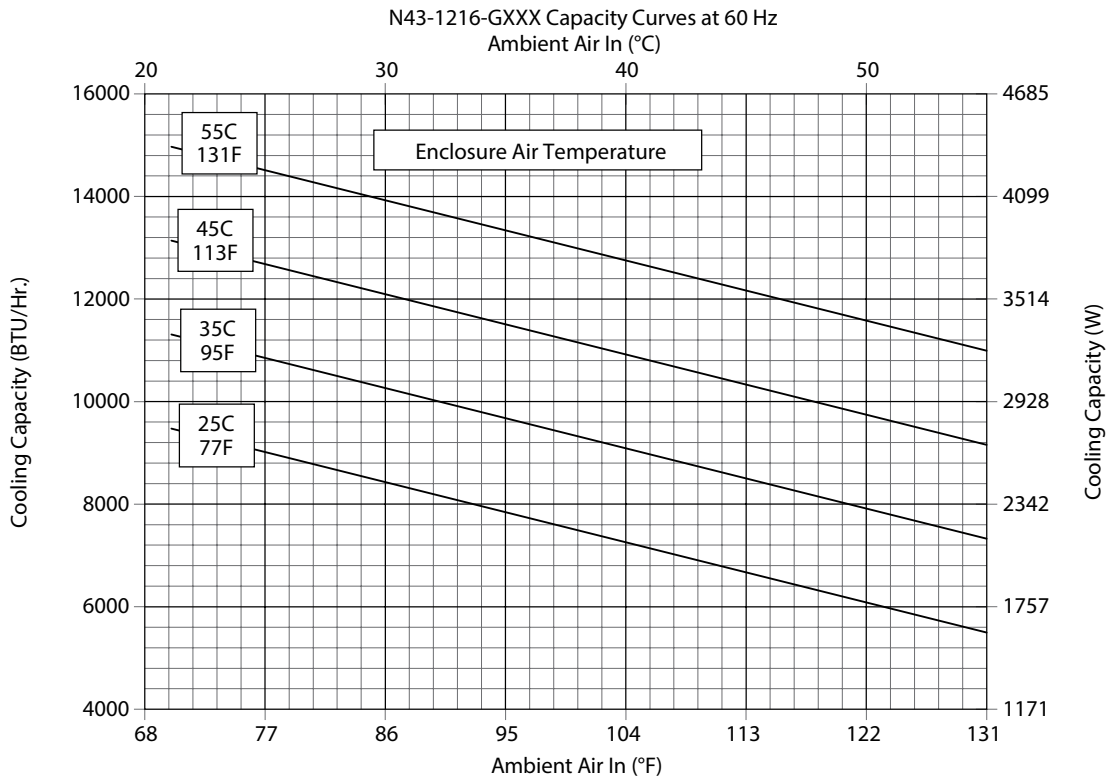
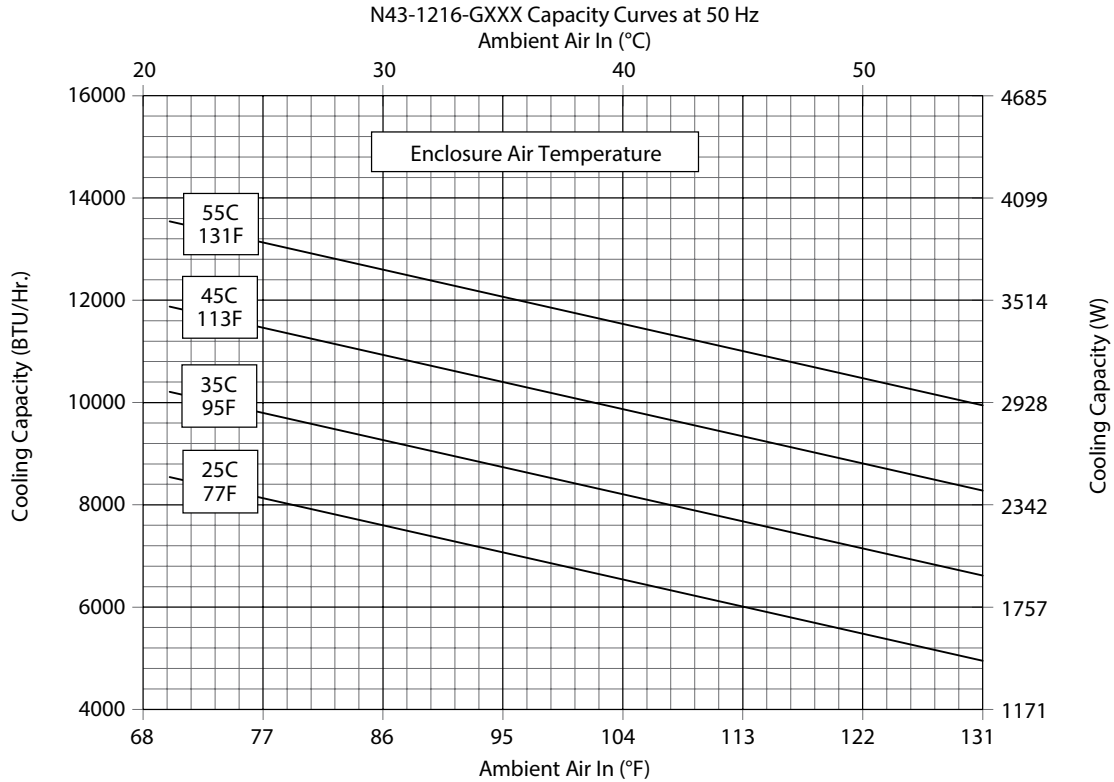

Performance Curves for N43 Models 11000 BTU/Hr. (3223 Watt)

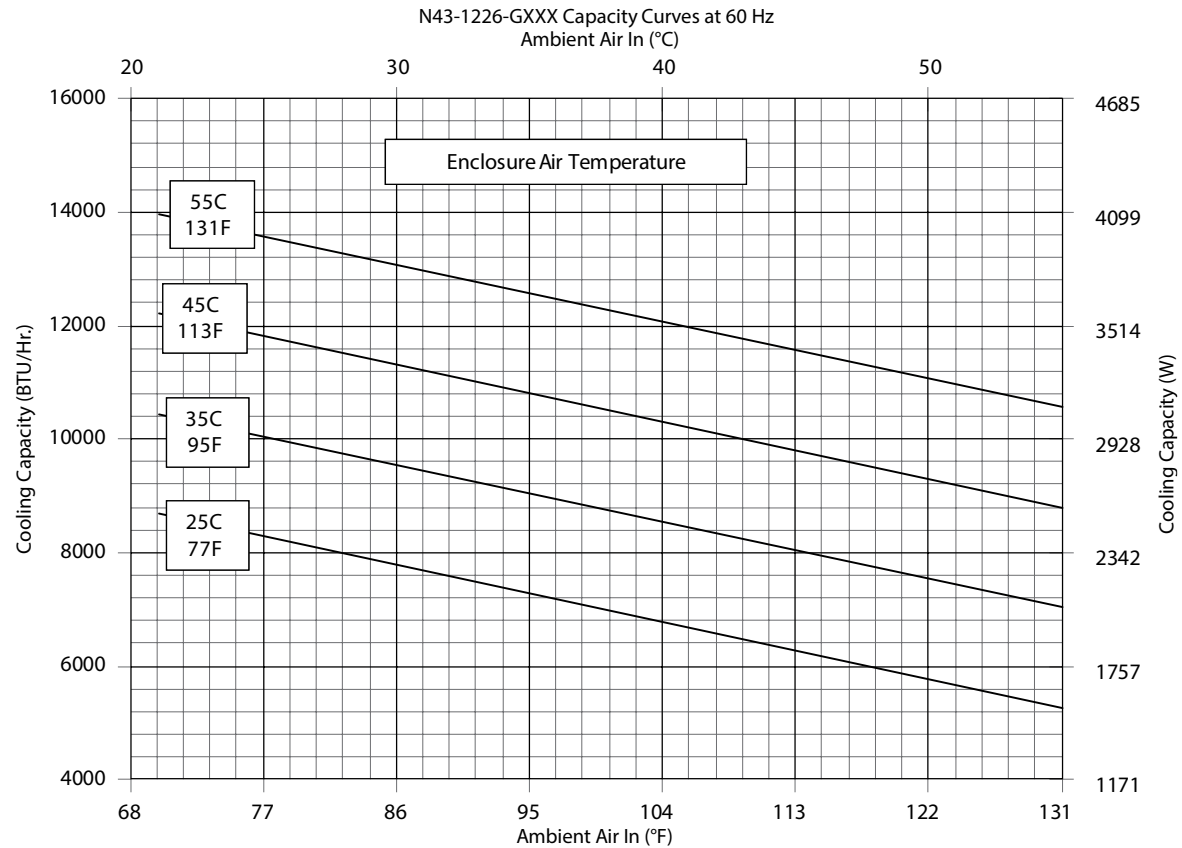
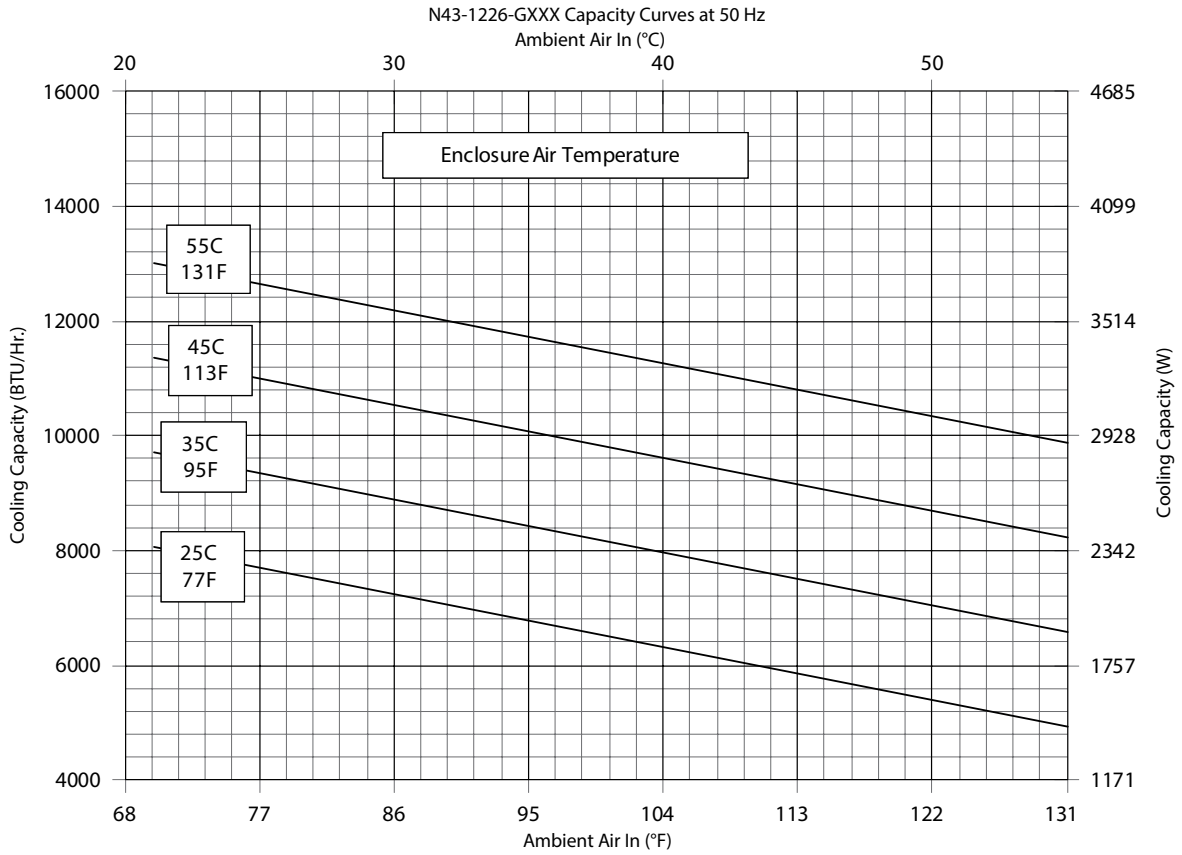

Performance Curves for N43 Models 11000 BTU/Hr. (3223 Watt)

N43-1246-GXXX Capacity Curves at 50 Hz
Ambient Air In (°C)

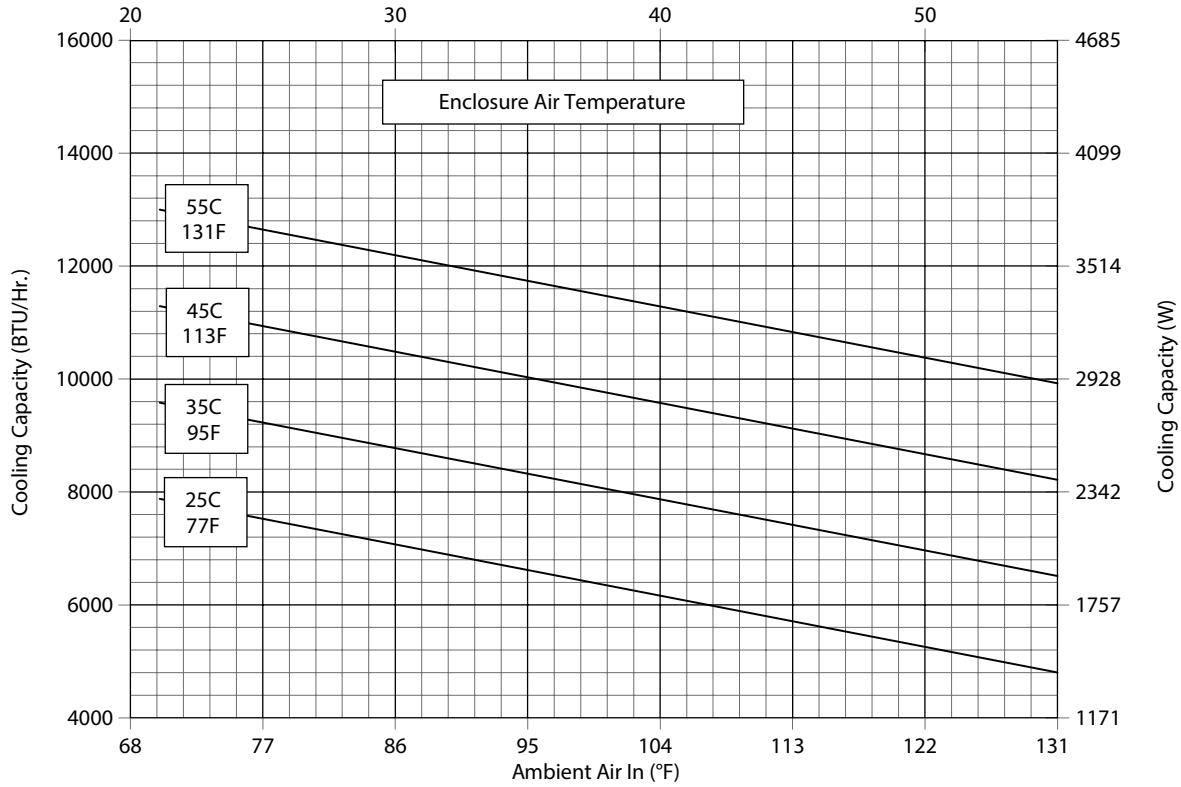

N43-1246-GXXX Capacity Curves at 60 Hz
Ambient Air In (°C)

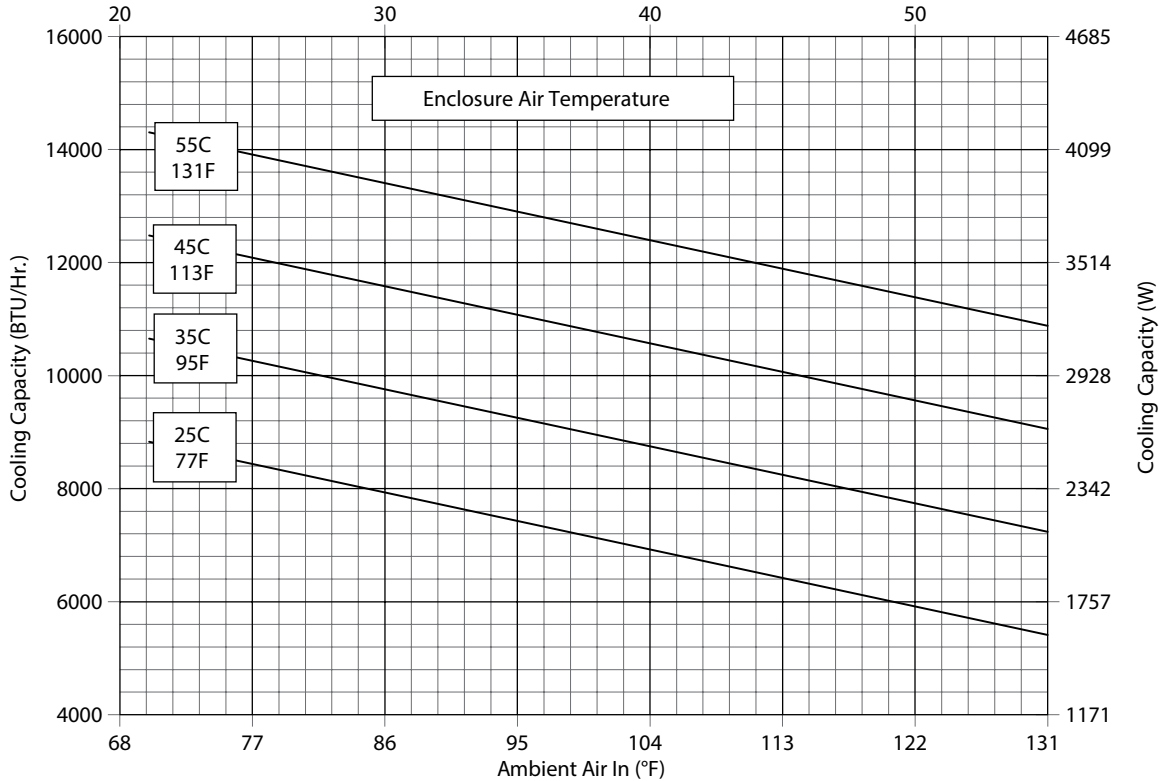

N43 12000 BTU/Hr. (3516 Watt)

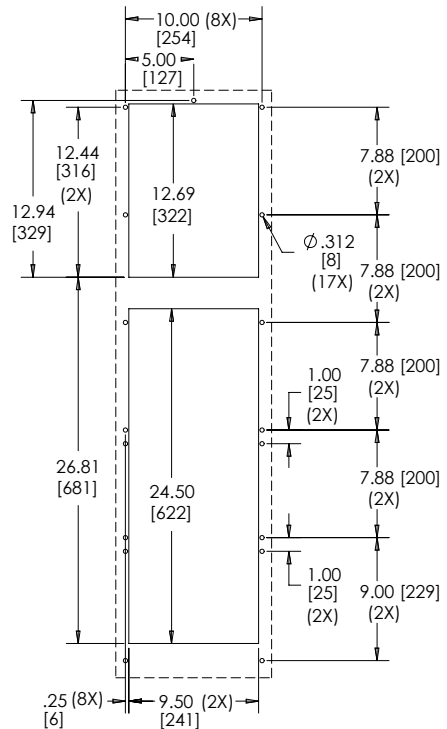
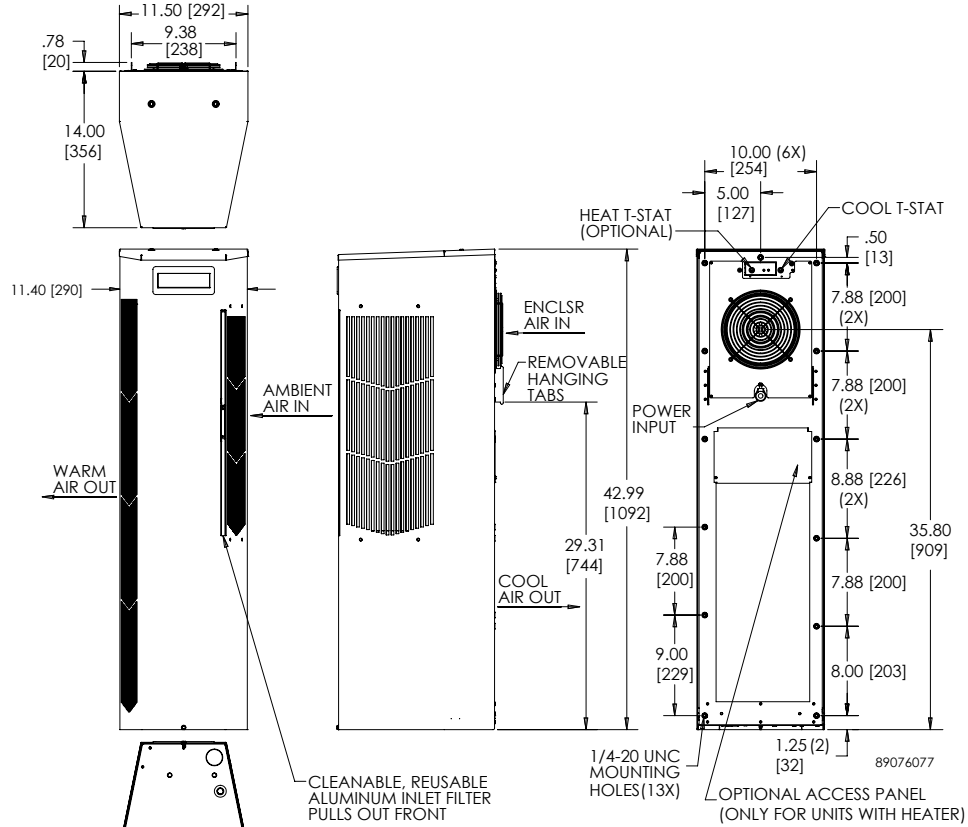

Visit www.nVent.com/HOFFMAN to download 2D and 3D CAD drawings into the overall design of your electrical system.

Notes